

HAVA KOMPRESÖRLERİ//AIR COMPRESSORS
DEBRİYAJ ALT MERKEZLERİ//CLUTCH MASTER CYLINDERS
DEBRİYAJ ÜST MERKEZLERİ//CLUTCH SERVOS
KURUTUCU TAHLİYE VALFLERİ//AIR DRYERS
KÖRÜK VENTİLLERİ//VALVES
VE TAMİR TAKIMLARI//REPAIR KITS FOR THEM

GENERAL PRODUCT CATALOGUE

GENEL ÜRÜN KATALOĞU

MAN / MERCEDES / VOLVO / SCANIA / DAF / RENAULT / IVECO / FORD / DEUTZ / MAGIRUS / ISUZU...



yumak[®]
AIR BRAKE SYSTEMS



www.mehmetyumak.com

GENERAL CATALOG

**Version
1.2.6**



the world quality in TURKEY



Hakkımızda//About Us

YUMAK otomotiv yük ve yolcu taşımacılığında kullanılan ticari araçların havalı fren aksamlarında kullanılan parçaların yedek parça ve tamir takımı imalatını yapmaktadır.

KONYA - TÜRKİYE merkezli bir şirkettir. Şirketimiz başta Avrupa ülkeleri olmak üzere her kıtada toplam 58 ülkeye ihracat yapıyor. Bünyemizde barındırdığımız ileri teknoloji tezgahlar ile 8.000 metrekare kapalı alanda üretim yapmaktayız.

Until 1975 Yumak Otomotiv produce commercial vehicles air compressor, clutch servos (clutch booster) clutch master cylinders, air dryer units, levelling valves, brake systems and repair kits for them. Those parts are widely used in trucks, trailers and buses such as; VOLVO, SCANIA, MERCEDES BENZ, IVECO, PEUGOET, MAN, RENAULT, DAF, ISUZU etc..

Her zaman daha iyiyi
hedefleyen firmamız derki:

EN İYİSİ HENÜZ ÜRETİLMEDİ...

THE BEST PRODUCT WAS NOT PRODUCED YET!





Üretim // Production Line

Kaliteli hammaddeden kaliteli ürün elde edilir felsefesini asla unutmuyoruz. Birinci sınıf hammaddeleri kullanarak en ileri teknolojiye sahip tezgâhlarımızla, konusunda uzman döküm, talaşlı imalat, montaj ekiplerimizle kalitemizi daha mükemmelere ulaştırmak için çalışıyoruz. Üretimin her aşamasında (giriş, proses ve final kalite kontrol) sıkı kalite kontrol yaparak minimum risk politikasıyla maksimum kontrol ve minimum hata prensibiyle çalışıyoruz. Personel ve tedarikçi geliştirme programları ile sürekli olarak kendimizi ve tedarikçilerimizi yeniliyoruz. Biz bu yarışta en iyilerini üretmek için çalışıyoruz. Her ürünümüzün bir öncekinden daha iyi olmasını hedefleyerek emin adımlarla bu yarışa devam ediyoruz. Sonuç olarak diyoruz ki: EN İYİSİ HENÜZ ÜRETİLMEDİ.

We always follow the philosophy of 'Quality materials - quality products.'

In order to keep possible production defects and risk at minimum, quality control at maximum level, we do all the production process from casting to mounting by ourselves checking quality in each stage. In a laboratory of quality control our engineers conduct test on functionality. Performance capacity and stability (as well as tests for impermeability and strength) on special measuring equipments. In production line we use Japanese CNC machines and other universal machines which allow us to manufacture high quality products for commercial vehicles such as VOLVO, SCANIA, MERCEDES BENZ, IVECO, MAN, DAF, RENAULT with guarantee according to World Standards. Our engineers and technical group continuously work on researches and developments. Pay a great attention to the motto: 'Do it right in a first time and every time' in each step of the production process.



**En iyisi henüz üretilmedi!
THE BEST PRODUCT WAS NOT PRODUCED YET!**

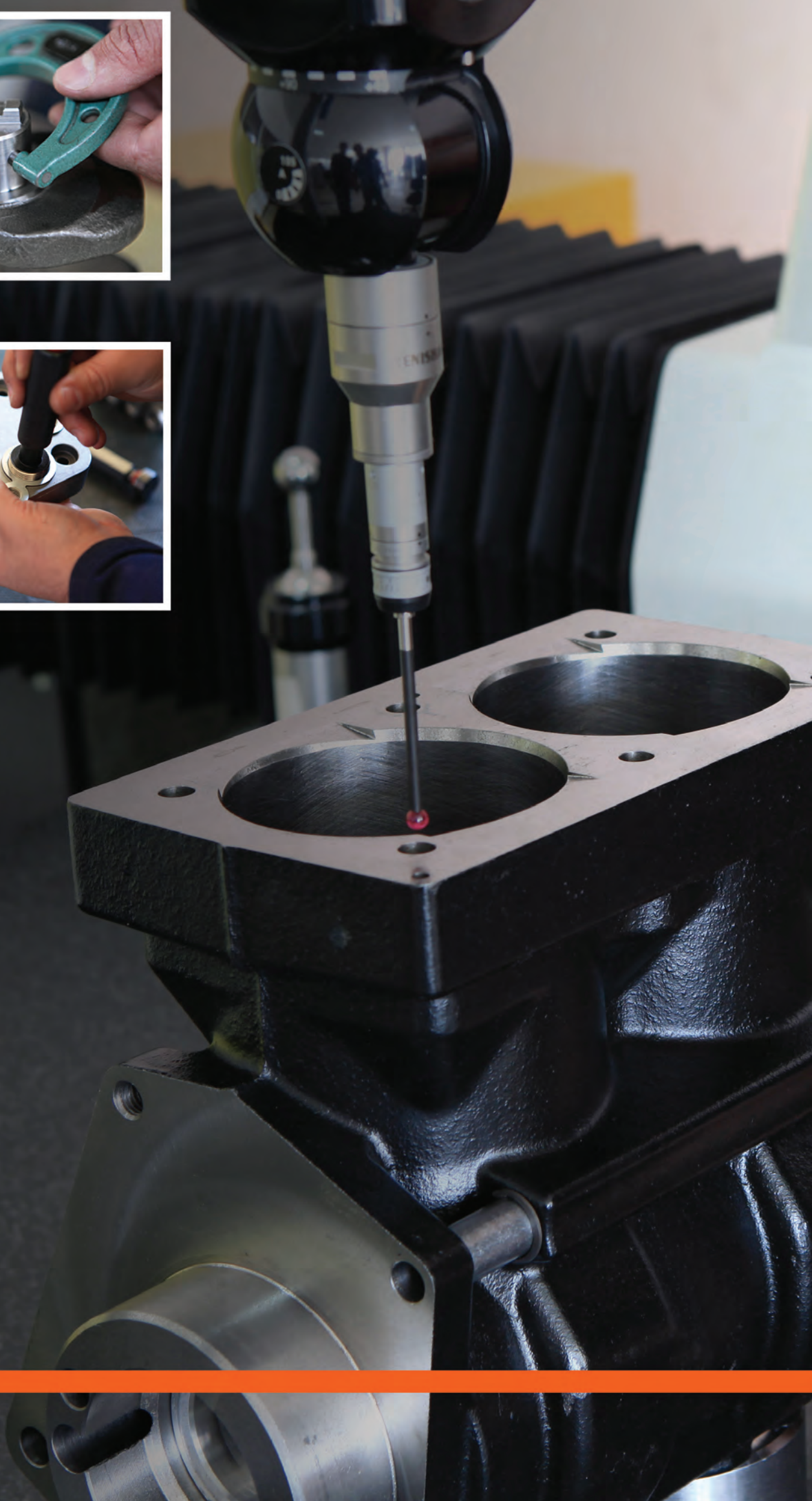

Kalite Politikamız//Our Quality Policy

Kalite anlayışımızla sektörde öncü firma olmak

Müşteri memnuniyetini en üst seviyede sağlamak

Tedarikçilerimizin bizimle birlikte gelişmesini sağlamak

Kaynaklarımızı en etkin şekilde kullanarak verimliliği sağlamak

Personelimizin eğitimlerine önem vererek gerekli her türlü eğitimi edinmelerini sağlamak

Personelin ve gerekli tüm proseslerin sürekli iyileştirilmesini sağlamak

Önce kalite anlayışını tüm çalışanlarımıza benimsetmek

Being a leader in a sector with our quality approach

Keep customer satisfaction on a top level

Improvement together with suppliers

Productivity and best use of resources

All kinds of needed education and training programs for personnel

Acceptance of quality approach by all workers of the company

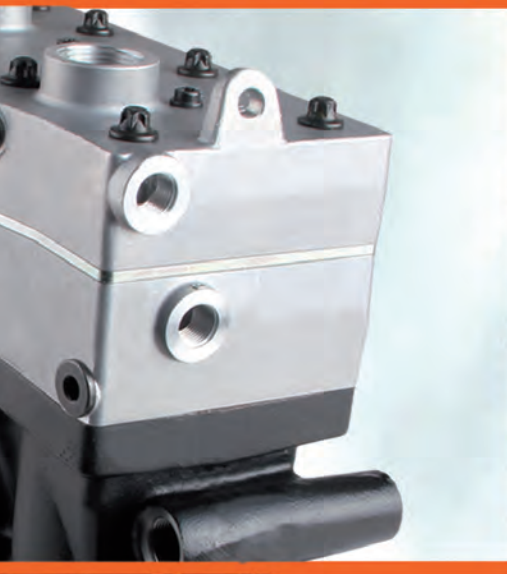
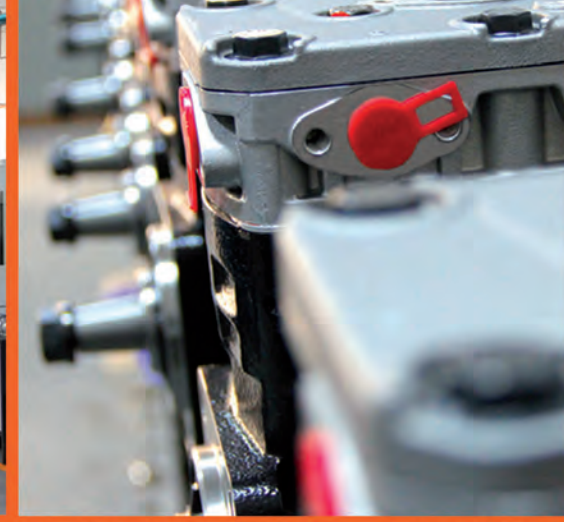

EXPORTING to

6 Continental **63** Countries

Registered trademark

in **107** countries



AIR BRAKE SYSTEMS

yumak[®]
AIR BRAKE SYSTEMS



Yumak No.	Reference No.	Page No.
01.06.005	412.352.010.0	64
01.06.005	457.130.1715	64
01.06.006	911.553.002.0	66
01.06.006	457.130.1815	66
01.06.007	911.553.103.0	68
01.06.007	457.130.2215	68
01.06.013	412.636.010.0	70
01.06.013	906.131.5219	70
01.06.013	906.131.5219	70
01.06.014	412.352.001.0	72

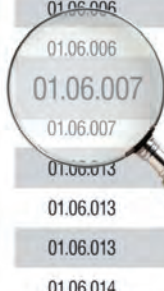

1

Reference No.	Yumak No.	Page No.
911.553.003.0	01.06.027	80
911.553.007.0	01.06.062	80
911.553.100.0	01.06.029	68
911.553.101.0	01.06.028	68
911.553.103.0	01.06.007	68
911.553.104.0	01.06.030	68
911.553.105.0	01.06.026	68
911.553.200.0	01.06.026	78
911.553.203.0	01.06.032	78
912.116.000.0	01.06.060	200

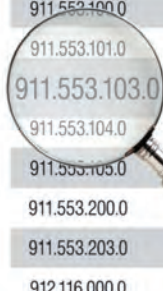

2

Reference No.	Yumak No.	Page No.
911.553.003.0	01.06.027	80
911.553.007.0	01.06.062	80
911.553.100.0	01.06.029	68
911.553.101.0	01.06.028	68
911.553.103.0	01.06.007	68
911.553.104.0	01.06.030	68
911.553.105.0	01.06.026	68
911.553.200.0	01.06.026	78
911.553.203.0	01.06.032	78
912.116.000.0	01.06.060	200



3

MERCEDES



1 01.06.007 / 01.06.028 / 01.06.029
01.06.030 / 01.06.031

Ø85mm 636CC Stroke 56mm

APPLICATION
MERCEDES AXOR
DEM REF

2 911.553.103.0 457.130.2215
457.130.1915
911.553.100.0 - 457.130.1215
911.553.104.0 - 457.130.2515
911.553.105.0 - 457.130.2715

RK.01.166 Cylinder Head With Plate Kit

Oem Ref. No:
911.553.001.2
001.130.0815
000.131.5219
001.130.2515

Dimensions : M16X1,5

RK.01.129.05 Valve Plate Kit

Oem Ref. No:
001.130.2315
001.130.2815

01.458 Cylinder Head

Oem Ref. No:

RK.01.129 Repair Kit

Oem Ref. No:

3
68

02.02.001

CLUTCH SERVOS

Oem Ref. No:

9700511020
6992950018
658882
637206630
624993
262077
4776623
42064599

Oil:

Synthetic
Sentetik

Vehicle:

MERCEDES
DAF
IVECO
VAN HOOL



RK.02.001

REPAIR KITS

Oem Ref. No:

9700519042



RK.02.080



02.272

02.02.002

CLUTCH SERVOS

Oem Ref. No:

9700511070
1518242
343362
345362

Oil:

Synthetic
Sentetik

Vehicle:

SCANIA 3SERIES
142 E450
143 E420
112/113/114



RK.02.002

REPAIR KITS

Oem Ref. No:

9700519062
5001832980
5000814928
550457



RK.02.082



02.272

REPAIR KITS

RK.02.033

Oem Ref. No:

9700510062



02.02.003

CLUTCH SERVOS

Oem Ref. No:

9700511110
81307256014
81307256026
81307256027
81307259026
93156099
40320400

Oil:

Synthetic
Sentetik

Vehicle:

MAN
12.192F/12.222F/12.232F
12.262F/12.272FL/14.162
14.152/14.192/17.192
DAF/IVECO/NEOPLAN



RK.02.003

REPAIR KITS

Oem Ref. No:

9700519052



RK.02.084



02.273

REPAIR KITS

RK.02.033

Oem Ref. No:

9700510062



CLUTCH SERVOS

02.02.004

CLUTCH SERVOS

Oem Ref. No:

9700511140
659807
85300019892
500362256
42037229 / 72037766
2477724
42061949 / 42063552
8383236000

Oil:

Synthetic
Sentetik

Vehicle:

IVECO/LEYLAND/NATO
DAF/NISSAN/ HINO
MAN
EVOBUS



RK.02.001

REPAIR KITS

Oem Ref. No:

9700519042



RK.02.081



02.277

02.02.005

CLUTCH SERVOS

Oem Ref. No:

9700511240
1518244
5001136770
5000787875
503135313
5001824707
700511240
5000787875
5001832980

Oil:

Synthetic
Sentetik

Vehicle:

RENAULT R.V.I.
IVECO
DAF



RK.02.002

REPAIR KITS

Oem Ref. No:

9700519062
5001832980



RK.02.082



02.272

REPAIR KITS

RK.02.033

Oem Ref. No:

9700510062



02.02.006

CLUTCH SERVOS

Oem Ref. No:

9700511260
1518245
42037229
5000815689
637208440
42037766
42061949
42063552
042320200

Oil:

Synthetic
Sentetik

Vehicle:

RENAULT R.V.I
IVECO
DAF
NISSAN
HINO
NEOPLAN



RK.02.001

REPAIR KITS

Oem Ref. No:

9700519042



RK.02.081



02.277

02.02.007

CLUTCH SERVOS

Oem Ref. No:

9700511270
1519273
04791101
040320100

Oil:

Hydraulic
Hidrolik

Vehicle:

IVECO - 330
P/PA330-36H/330-36HT
SCANIA



RK.02.002

REPAIR KITS

Oem Ref. No:

9700519062
5001832980



RK.02.083



02.277

02.02.008

CLUTCH SERVOS

Oem Ref. No:

9700511280
1518246
0012955607

Oil:

Synthetic
Sentetik

Vehicle:

SCANIA



RK.02.002

REPAIR KITS

Oem Ref. No:

9700519062
5001832980



RK.02.083



02.277

02.02.009

CLUTCH SERVOS

Oem Ref. No:

9700511290
0281009
286295
8285280000
9522002210

Oil:

Synthetic
Sentetik

Vehicle:

DAF 3300
EVOBUS
KAESSBOHRER
SCHMITZ



RK.02.004

REPAIR KITS

Oem Ref. No:

9700519102
066873
0002900647



RK.02.086



02.273

CLUTCH SERVOS

02.02.010

CLUTCH SERVOS

Oem Ref. No:
9700511310
1518247
0012953101
0012956707
0012953107
8383240000
0012952207
8383231000

Oil:
Hydraulic
Hidrolik

Vehicle:
MERCEDES
SETRA
EVOBUS



RK.02.005

REPAIR KITS

Oem Ref. No:
9700519032
0002900667



02.02.011

CLUTCH SERVOS

Oem Ref. No:
9700511320
1518248
1197265
81307256032

Oil:
Synthetic
Sentetik

Vehicle:
MAN 422
DAF
ERF



RK.02.006

REPAIR KITS

Oem Ref. No:
9700519112
81307256047



RK.02.086



02.273

02.02.012

CLUTCH SERVOS

Oem Ref. No:
9700511350

Oil:
Synthetic
Sentetik

Vehicle:
MERCEDES
RENAULT
DAF



RK.02.004

REPAIR KITS

Oem Ref. No:
9700519102
066873
0002900647



RK.02.86



02.273

02.02.013
CLUTCH SERVOS
Oem Ref. No:

9700511370
1518249
0002950018
1506456

Oil:

Hydraulic
Hidrolik

Vehicle:

MERCEDES 3031
DAF

RK.02.004
REPAIR KITS
Oem Ref. No:

9700519102
066873
0002900647

RK.02.087

02.276

02.02.014
CLUTCH SERVOS
Oem Ref. No:

9700511500
753259

Oil:

Synthetic
Sentetik

Vehicle:

DAF

RK.02.004
REPAIR KITS
Oem Ref. No:

9700519102
066873
0002900647

RK.02.086

02.273

02.02.015
CLUTCH SERVOS
Oem Ref. No:

9700511510
1518250

Oil:

Synthetic
Sentetik

Vehicle:

MERCEDES
1420LS/1827S/1827LS
1120/1124/1320/1324
1520/1524/1724/2024
1417/1726/1727/1729

RK.02.007
REPAIR KITS
Oem Ref. No:

9700519172



CLUTCH SERVOS

02.02.016

CLUTCH SERVOS

Oem Ref. No:
9700511580
9700511460
1506456
0002951518

Oil:
Hydraulic
Hidrolik

Vehicle:
MERCEDES
2411B/2426/2427/2527
2531/2629/2631/3229
3233/3238/3244/3253
3534/3535/3544/3550
4844/0404



RK.02.010

REPAIR KITS

Oem Ref. No:
9700519162
0002900347
21702250



02.02.017

CLUTCH SERVOS

Oem Ref. No:
9700511590
1518252
0002951418
0002950918
0002950218

Oil:
Synthetic
Sentetik

Vehicle:
MERCEDES



RK.02.010

REPAIR KITS

Oem Ref. No:
9700519162
0002900347
21702250



02.02.018

CLUTCH SERVOS

Oem Ref. No:
9700511630
0002950718

Oil:
Synthetic
Sentetik

Vehicle:
MERCEDES



RK.02.009

REPAIR KITS

Oem Ref. No:
9700519442



RK.02.094



02.276

02.02.019

CLUTCH SERVOS

Oem Ref. No:
9700511640
0002951318
0002950718

Oil:
Hydraulic
Hidrolik

Vehicle:
MERCEDES
NEOPLAN



RK.02.032

REPAIR KITS

RK.02.118

Oem Ref. No:
9700519452
9700519552
0002901447
042332200



02.276



02.02.020

CLUTCH SERVOS

Oem Ref. No:
9700511650
042321100

Oil:
Synthetic
Sentetik

Vehicle:
MERCEDES
NEOPLAN



RK.02.009

REPAIR KITS

RK.02.095

Oem Ref. No:
9700519442



02.273



02.02.021

CLUTCH SERVOS

Oem Ref. No:
9700511760
1506459
110100800
8383000238

Oil:
Synthetic
Sentetik

Vehicle:
MAN
NEOPLAN
EVOBUS



RK.02.012

REPAIR KITS

RK.02.099

Oem Ref. No:
9700519502



02.279



CLUTCH SERVOS

02.02.022

CLUTCH SERVOS

Oem Ref. No:
9700511820

Oil:
Hydraulic
Hidrolik

Vehicle:



RK.02.002

REPAIR KITS

RK.02.082

Oem Ref. No:
9700519062
5001832980



02.272

02.02.023

CLUTCH SERVOS

Oem Ref. No:
9700512040
1519280
42062535
042320300

Oil:
Synthetic
Sentetik

Vehicle:
NEOPLAN
DAF
IVECO
RENAULT



RK.02.001

REPAIR KITS

RK.02.081

REPAIR KITS

RK.02.145

Oem Ref. No:
9700519042



02.277



Oem Ref. No:
9700519412

02.02.024

CLUTCH SERVOS

Oem Ref. No:
9700512050
1519281
104084

Oil:
PENTOSIL

Vehicle:
DAF
IVECO



RK.02.030.P

REPAIR KITS

RK.02.113.P

REPAIR KITS

RK.02.062

Oem Ref. No:
9700519072



02.276



Oem Ref. No:
9700519372

02.02.025

CLUTCH SERVOS

Oem Ref. No:
9700512090
1518254
5000673126
5001824708
5001832990
624445
5000675126

Oil:
Hydraulic
Hidrolik

Vehicle:
RENAULT MIDLINER
M210.12/C
DAF
IVECO



RK.02.011

REPAIR KITS

Oem Ref. No:
9700519092
5000814530



RK.02.097



02.272

REPAIR KITS

RK.02.062

Oem Ref. No:
9700519372



02.02.026

CLUTCH SERVOS

Oem Ref. No:
9700512100
0097539
8285379000
040320210
11006567
5000673126

Oil:
Synthetic
Sentetik

Vehicle:
EVOBUS
DAF
NEOPLAN
LEYLAND



RK.02.004

REPAIR KITS

Oem Ref. No:
9700519102
066873
0002900647



RK.02.085



02.272

REPAIR KITS

RK.02.062

Oem Ref. No:
9700519372



02.02.027

CLUTCH SERVOS

Oem Ref. No:
9700513070
81307256064
81307256065
81307259064

Oil:
Synthetic
Sentetik

Vehicle:
MAN F2000
19.233FCN6
19.273F-FL-L/19.293
19.314/19.323/19.343
19.364/19.373/19.403
19.414/23.293/23.403
23.463/24.273/24.293
24.343



RK.02.014

REPAIR KITS

Oem Ref. No:
9700519432



RK.02.102



02.273

CLUTCH SERVOS

02.02.028

CLUTCH SERVOS

Oem Ref. No:
9700514010

Oil:
Hydraulic
Hidrolik

Vehicle:



RK.02.048

REPAIR KITS

Oem Ref. No:
9700519712



RK.02.125



02.273

REPAIR KITS

RK.02.056

Oem Ref. No:
9700519862
4411005312
0015429318



02.02.029

CLUTCH SERVOS

Oem Ref. No:
9700514050
0002952818
0002953718
0002540047
0002540247
0002540747

Oil:
Synthetic
Sentetik

Vehicle:
MERCEDES ACTROS
1831 / 1835 / 1840/1843
2031 2040 / 2053 / 2531
2535 / 2540 / 2543 / 2640
2643 / 2648 / 3331 / 3335
3340 / 3343 / 3348



RK.02.013

REPAIR KITS

Oem Ref. No:
9700519492



RK.02.100



02.276

REPAIR KITS

RK.02.149

Oem Ref. No:
9700519682



REPAIR KITS

RK.02.056

Oem Ref. No:
9700519862/4411005312
0015429318



02.02.030

CLUTCH SERVOS

Oem Ref. No:
9700511520
043220800
11010076
0002952318

Oil:
Synthetic
Sentetik

Vehicle:
NEOPLAN
MERCEDES



RK.02.006

REPAIR KITS

Oem Ref. No:
9700519112
81307256047



RK.02.089



02.273

02.02.031

CLUTCH SERVOS

Oem Ref. No:

9700514060
1505141
81307256049
81307256067
81307256069

Oil:

Hydraulic
Hidrolik

Vehicle:

DAF
MAN



RK.02.015

REPAIR KITS

Oem Ref. No:

9700519522



RK.02.107



02.279

02.02.032

CLUTCH SERVOS

Oem Ref. No:

9700514140
81307256086
622500
1518255
81307256065
81307256074
81307256093
625436
628027

Oil:

Synthetic
Sentetik

Vehicle:

MAN F2000
DAF



RK.02.029

REPAIR KITS

Oem Ref. No:

9700519612
81307256091



RK.02.112



02.279

02.02.033

CLUTCH SERVOS

Oem Ref. No:

9700514310
1506468
0002540047
0002952818

Oil:

Synthetic
Sentetik

Vehicle:

MERCEDES AXOR - ACTROS
1831
1835/1840/1843/2031/2040
2053/2531/2535/2540/2543
2640/2643/2648/3331/3335
3340/3343/3348
TRAVEGO



RK.02.016

REPAIR KITS

Oem Ref. No:

9700519742
0002500262



RK.02.109



02.276

REPAIR KITS



RK.02.056

Oem Ref. No:

9700519862
4411005312
0015429318

CLUTCH SERVOS

02.02.034

CLUTCH SERVOS

Oem Ref. No:
9700514240
5010556022
1506467
657309
659826
230716001

Oil:
Hydraulic
Hidrolik

Vehicle:
DAF
IVECO
MERCEDES
PRO 1142



RK.02.029

REPAIR KITS

RK.02.112

Oem Ref. No:
9700519612
81307256091



02.279



02.02.035

CLUTCH SERVOS

Oem Ref. No:
9700511680

Oil:
Synthetic
Sentetik

Vehicle:



RK.02.026

REPAIR KITS

RK.02.110

Oem Ref. No:
9700519192



02.273



02.02.037

CLUTCH SERVOS

Oem Ref. No:
9700511360
0390486
2590123169923

Oil:
Synthetic
Sentetik

Vehicle:
DAF
LEYLAND
NATO



RK.02.135

REPAIR KITS

Oem Ref. No:
9700519132



02.273



02.02.040
CLUTCH SERVOS
Oem Ref. No:
9700511560

Oil:
Hydraulic
Hidrolik

Vehicle:

RK.02.004
REPAIR KITS
Oem Ref. No:
9700519102
066873
0002900647

RK.02.086

02.273

02.02.041
CLUTCH SERVOS
Oem Ref. No:
9700511570
1518251
81307256053
81307256054
81307259054
622586
81307256031

Oil:
Synthetic
Sentetik

Vehicle:
DAF
MAN

RK.02.006
REPAIR KITS
Oem Ref. No:
9700519112
81307256047

RK.02.089

02.273

REPAIR KITS
RK.02.033
Oem Ref. No:
9700510062

02.02.042
CLUTCH SERVOS
Oem Ref. No:
9700511610
0002951818

Oil:
Synthetic
Sentetik

Vehicle:
MERCEDES

RK.02.134
REPAIR KITS
Oem Ref. No:
9700519182
0002900347

CLUTCH SERVOS

02.02.043

CLUTCH SERVOS

Oem Ref. No:
9700511620
1505261
0002950818

Oil:
Hydraulic
Hidrolik

Vehicle:
DAF
MERCEDES 1827S-SL-L



RK.02.007

REPAIR KITS

Oem Ref. No:
9700519172
9700219512



02.072

REPAIR KITS



02.02.044

CLUTCH SERVOS

Oem Ref. No:
9700511660
3842957018
0002952118

Oil:
Synthetic
Sentetik

Vehicle:
MERCEDES



RK.02.042

REPAIR KITS

Oem Ref. No:
9700519462



RK.02.121



02.272

02.02.045

CLUTCH SERVOS

Oem Ref. No:
9700511690
1515253
0281009
83833310003
9522002210

Oil:
Synthetic
Sentetik

Vehicle:
DAF
EVOBUS
KAESSBOHRER
SCHMITZ



RK.02.004

REPAIR KITS

Oem Ref. No:
9700519102
066873
0002900647



RK.02.088



02.279

02.02.046

CLUTCH SERVOS

Oem Ref. No:
9700511700
81307259062
81307256062

Oil:

Vehicle:
MAN



RK.02.026

REPAIR KITS

RK.02.110

Oem Ref. No:
9700519192



02.273

02.02.047

CLUTCH SERVOS

Oem Ref. No:
9700511730

Oil:
Hydraulic
Hidrolik

Vehicle:
MAN



RK.02.006

REPAIR KITS

RK.02.092

Oem Ref. No:
9700519112
81307256047



02.279

02.02.048

CLUTCH SERVOS

Oem Ref. No:
9700511740
1506458
0002952318

Oil:
Synthetic
Sentetik

Vehicle:
DAF
MERCEDES



RK.02.042

REPAIR KITS

RK.02.089

Oem Ref. No:
9700519462



02.273

CLUTCH SERVOS

02.02.049

CLUTCH SERVOS

Oem Ref. No:
9700511770
89199250134

Oil:
Hydraulic
Hidrolik

Vehicle:
EVOBUS
FAUN



RK.02.004

REPAIR KITS

RK.02.088

Oem Ref. No:
9700519102
066873
0002900647



02.279



02.02.050

CLUTCH SERVOS

Oem Ref. No:
9700511780

Oil:
Synthetic
Sentetik

Vehicle:



RK.02.006

REPAIR KITS

RK.02.089

Oem Ref. No:
9700519112
81307256047



02.273



02.02.051

CLUTCH SERVOS

Oem Ref. No:
9700511800

Oil:
Synthetic
Sentetik

Vehicle:
DAF
MERCEDES



RK.02.012

REPAIR KITS

RK.02.129

Oem Ref. No:
9700519502



02.276



02.02.052

CLUTCH SERVOS

Oem Ref. No:

9700511830
89199250134
1506460
8383000232

Oil:

Hydraulic
Hidrolik

Vehicle:

DAF
EVOBUS



RK.02.004

REPAIR KITS

Oem Ref. No:

9700519102
066873
0002900647



RK.02.088



02.279

02.02.054

CLUTCH SERVOS

Oem Ref. No:

9700511900
0002540147

Oil:

Synthetic
Sentetik

Vehicle:

DAF
MERCEDES



RK.02.007

REPAIR KITS

Oem Ref. No:

9700519172
0002901347



RK.02.093



02.272

02.02.055

CLUTCH SERVOS

Oem Ref. No:

9700512170
1506462
81307256060

Oil:

Synthetic
Sentetik

Vehicle:

DAF
MAN
NEOPLAN



RK.02.006

REPAIR KITS

Oem Ref. No:

9700519112
81307256047



RK.02.130



02.277

REPAIR KITS

RK.02.024

Oem Ref. No:

9700519382



CLUTCH SERVOS

02.02.056

CLUTCH SERVOS

Oem Ref. No:
9700512180
1519283
5010244109

Oil:
Hydraulic
Hidrolik

Vehicle:
DAF
RENAULT



RK.02.041

REPAIR KITS

Oem Ref. No:
9700519482
5001838136



RK.02.120



02.276

REPAIR KITS

RK.02.062

Oem Ref. No:
9700519372



02.02.057

CLUTCH SERVOS

Oem Ref. No:
9700514090
5010245221

Oil:
Synthetic
Sentetik

Vehicle:
RENAULT



RK.02.044

REPAIR KITS

Oem Ref. No:
9700519572



RK.02.124



02.276

REPAIR KITS

RK.02.148

Oem Ref. No:
9700519602
5001845590



02.02.058

CLUTCH SERVOS

Oem Ref. No:
9700514130

Oil:
Synthetic
Sentetik

Vehicle:



RK.02.014

REPAIR KITS

Oem Ref. No:
9700519432



RK.02.104



02.279

02.02.059

CLUTCH SERVOS

Oem Ref. No:

9700514150
9700514380
50102458868
5010452511
1519286

Oil:

Hydraulic
Hidrolik

Vehicle:

DAF
IVECO
RENAULT



RK.02.044

REPAIR KITS

Oem Ref. No:

9700519572



RK.02.124



02.276

REPAIR KITS

RK.02.148

Oem Ref. No:

9700519602
5001845590



02.02.060

CLUTCH SERVOS

Oem Ref. No:

9700514360
1147633
0002540347
1525406

Oil:

Synthetic
Sentetik

Vehicle:

DAF
MERCEDES



RK.02.031

REPAIR KITS

Oem Ref. No:

9700519752



RK.02.116



02.276

02.02.061

CLUTCH SERVOS

Oem Ref. No:

9700514370

Oil:

Synthetic
Sentetik

Vehicle:



RK.02.029

REPAIR KITS

Oem Ref. No:

9700519612
81307256091



RK.02.112



02.279

CLUTCH SERVOS

02.02.062

CLUTCH SERVOS

Oem Ref. No:
9700514230
1506466
501006570
7C467K626AA

Oil:
Hydraulic
Hidrolik

Vehicle:
DAF
FORD
MAN
RENAULT



RK.02.029

REPAIR KITS

RK.02.112

Oem Ref. No:
9700519612
81307256091



02.279



02.02.063

CLUTCH SERVOS

Oem Ref. No:
9700514070

Oil:
Synthetic
Sentetik

Vehicle:



RK.02.014

REPAIR KITS

RK.02.102

Oem Ref. No:
9700519432



02.273



02.02.064

CLUTCH SERVOS

Oem Ref. No:
9700514380
1519286
504130066
5010452511

Oil:
Synthetic
Sentetik

Vehicle:
DAF
IVECO
MAN
MERCEDES
RENAULT RVI 400/420



RK.02.043

REPAIR KITS

RK.02.122

REPAIR KITS

RK.02.148

Oem Ref. No:
9700519842



02.276



Oem Ref. No:
9700519602
5001845590



02.02.065
CLUTCH SERVOS
Oem Ref. No:
Oil:

 Hydraulic
Hidrolik

Vehicle:

HINO

 DOT3
DOT4
SAE J1703

RK.02.004
REPAIR KITS
Oem Ref. No:

 9700519102
066873
0002900647

RK.02.086

02.273

02.02.066
CLUTCH SERVOS
Oem Ref. No:

 9700511710
1519279
99434056
5010244123

Oil:

 Hydraulic
Hidrolik

Vehicle:

 DAF
IVECO
RENAULT
NEOPLAN

 DOT3
DOT4
SAE J1703

RK.02.009
REPAIR KITS
Oem Ref. No:

9700519442

RK.02.094

02.276

02.02.067
CLUTCH SERVOS
Oem Ref. No:

 9700511790
3842957018
0002952118

Oil:

 Synthetic
Sentetik

Vehicle:

MERCEDES

 DOT3
DOT4
SAE J1703

RK.02.032
REPAIR KITS
Oem Ref. No:

 9700519452
9700519552
0002901447
042332200

RK.02.117

02.272

CLUTCH SERVOS

02.02.068

CLUTCH SERVOS

Oem Ref. No:

9700514120
1506465

81307256084

81307256085

81307256089

81307256092

81307256107 / 81307259107

81307256109 / 81307259884

Oil:

MINERAL

Vehicle:

MAN TGA/TGL/TGM/TGX
18.310/18.350/18.360/18.410
18.430/18.460/18.480/18.510
19.360/19.460/19.480/24.350
26.280/26.310/26.320/33.310
33.350/33.400/35.310/24.320
TGS 18.320/18.360/18.400
NEOPLAN / DAF / LIONS COACH BUS
TGS-TGX-DÜZ ŞANZUMAN



RK.02.048.P

REPAIR KITS

Oem Ref. No:

9700519712

81307256099



RK.02.127.P



02.279

REPAIR KITS

RK.02.056

Oem Ref. No:

9700519862

4411005312

0015429318



02.02.069

CLUTCH SERVOS

Oem Ref. No:

9700514020

5010544401

Oil:

Hydraulic
Hidrolik

Vehicle:

RENAULT
MERCEDES

D18 ŞANZUMAN



RK.02.044

REPAIR KITS

Oem Ref. No:

9700519572



RK.02.124



02.276

REPAIR KITS

RK.02.148

Oem Ref. No:

9700519602

5001845590



02.02.070

CLUTCH SERVOS

Oem Ref. No:

9700514220

5010452512

9700513030

5010244220

Oil:

Hydraulic
Hidrolik

Vehicle:

RENAULT
PREMIUM/MAGNUM
390/420T/430/470/530
BMC PRO FATİH
MAN
IVECO
IRISBUS



RK.02.059

REPAIR KITS

Oem Ref. No:

9700519732

5001843797



RK.02.128



02.276

02.02.071

CLUTCH SERVOS

Oem Ref. No:
9700514450
0002540847

Oil:
Synthetic
Sentetik

Vehicle:
MERCEDES



RK.02.016

REPAIR KITS

Oem Ref. No:
9700519742



RK.02.109



02.276

02.02.072

CLUTCH SERVOS

Oem Ref. No:
9700514100
5010245488

Oil:
Synthetic
Sentetik

Vehicle:
RENAULT



RK.02.044

REPAIR KITS

Oem Ref. No:
9700519572



RK.02.124



02.276

REPAIR KITS

RK.02.148

Oem Ref. No:
9700519602
5001845590



02.02.073

CLUTCH SERVOS

Oem Ref. No:
9700511250

Oil:
Hydraulic
Hidrolik

Vehicle:



RK.02.006

REPAIR KITS

Oem Ref. No:
9700519112
81307256047



RK.02.090



02.276

CLUTCH SERVOS

02.02.074

CLUTCH SERVOS

Oem Ref. No:
9700511720
0501005138

Oil:
Synthetic
Sentetik

Vehicle:



RK.02.006

REPAIR KITS

RK.02.092

Oem Ref. No:
9700519112
81307256047



02.279



02.02.075

CLUTCH SERVOS

Oem Ref. No:
9700512060

Oil:
Synthetic
Sentetik

Vehicle:
DAF



RK.02.001

REPAIR KITS

RK.02.081

REPAIR KITS

RK.02.024

Oem Ref. No:
9700519042



02.277



Oem Ref. No:
9700519382



02.02.076

CLUTCH SERVOS

Oem Ref. No:
9700512070

Oil:
Hydraulic
Hidrolik

Vehicle:



RK.02.011

REPAIR KITS

RK.02.098

Oem Ref. No:
9700519092
5000814530



02.277



02.02.077

CLUTCH SERVOS

Oem Ref. No:
9700512110
637211820

Oil:
Synthetic
Sentetik

Vehicle:
VAN HOOL



RK.02.004

REPAIR KITS

Oem Ref. No:
9700519102
066873
0002900647



RK.02.086



02.273

REPAIR KITS

RK.02.062

Oem Ref. No:
9700519372



02.02.078

CLUTCH SERVOS

Oem Ref. No:
9700512140
81307256052

Oil:
Synthetic
Sentetik

Vehicle:
MAN
NEOPLAN



RK.02.011

REPAIR KITS

Oem Ref. No:
9700519092
5000814530



RK.02.098



02.277

REPAIR KITS

RK.02.024

Oem Ref. No:
9700519382



02.02.079

CLUTCH SERVOS

Oem Ref. No:
9700512200
1506463
83833320008
8285379000

Oil:
Hydraulic
Hidrolik

Vehicle:
DAF
EVOBUS



RK.02.004

REPAIR KITS

Oem Ref. No:
9700519102
066873
0002900647



RK.02.088



02.279

REPAIR KITS

RK.02.062

Oem Ref. No:
9700519372



CLUTCH SERVOS

02.02.080

CLUTCH SERVOS

Oem Ref. No:
9700512220
1261878

Oil:
Synthetic
Sentetik

Vehicle:
MAN



RK.02.037

REPAIR KITS

Oem Ref. No:
9700519672



RK.02.119



02.279

REPAIR KITS

RK.02.024

Oem Ref. No:
9700519382



02.02.081

CLUTCH SERVOS

Oem Ref. No:
9700512240
1519285

Oil:
Synthetic
Sentetik

Vehicle:
DAF



RK.02.037

REPAIR KITS

Oem Ref. No:
9700519672



RK.02.119



02.279

REPAIR KITS

RK.02.024

Oem Ref. No:
9700519382



02.02.082

CLUTCH SERVOS

Oem Ref. No:
9700514250
051006770

Oil:
Hydraulic
Hidrolik

Vehicle:



RK.02.048

REPAIR KITS

Oem Ref. No:
9700519712



RK.02.127



02.279

REPAIR KITS

RK.02.056

Oem Ref. No:
9700519862
4411005312
0015429318



02.02.083

CLUTCH SERVOS

Oem Ref. No:
9700514260

Oil:
Synthetic
Sentetik

Vehicle:



RK.02.060

REPAIR KITS

RK.02.136

Oem Ref. No:
9700519622



02.276

02.02.084

CLUTCH SERVOS

Oem Ref. No:
9700514290
5010452429
1524050
8846194220

Oil:
Synthetic
Sentetik

Vehicle:
RENAULT 220
MIDLUM
DAF



RK.02.137

REPAIR KITS

RK.02.138

Oem Ref. No:
9700519702



02.279

02.02.085

CLUTCH SERVOS

Oem Ref. No:
9700514300
5010452472

Oil:
Hydraulic
Hidrolik

Vehicle:
RENAULT



RK.02.137

REPAIR KITS

RK.02.138

Oem Ref. No:
9700519702



02.279

CLUTCH SERVOS

02.02.086

CLUTCH SERVOS

Oem Ref. No:
9700514320
81307256108

Oil:
Mineral

Vehicle:
MAN
NEOPLAN



RK.02.139.P

REPAIR KITS

Oem Ref. No:
9700519772



RK.02.140.P



02.279

REPAIR KITS

RK.02.056

Oem Ref. No:
9700519862
4411005312
0015429318



02.02.087

CLUTCH SERVOS

Oem Ref. No:
9700514330
0002953718
8846182500

Oil:
Hydraulic
Hidrolik

Vehicle:
MERCEDES



RK.02.016

REPAIR KITS

Oem Ref. No:
9700519742
0002500262



RK.02.109



02.276

REPAIR KITS

RK.02.056

Oem Ref. No:
9700519862
4411005312
0015429318



02.02.088

CLUTCH SERVOS

Oem Ref. No:
9700514350
5801275320

Oil:
Hydraulic
Hidrolik

Vehicle:
IVECO



RK.02.137

REPAIR KITS

Oem Ref. No:
9700519702



RK.02.138



02.279

02.02.089

CLUTCH SERVOS

Oem Ref. No:
9700514390
0501007330

Oil:
Synthetic
Sentetik

Vehicle:



DOT3
DOT4
SAE J1703

RK.02.043

REPAIR KITS

Oem Ref. No:
9700519842



RK.02.123



02.279

REPAIR KITS

RK.02.148

Oem Ref. No:
9700519602
5001845590



02.02.090

CLUTCH SERVOS

Oem Ref. No:
9700514400

Oil:
Synthetic
Sentetik

Vehicle:



DOT3
DOT4
SAE J1703

RK.02.015

REPAIR KITS

Oem Ref. No:
9700519522



RK.02.107



02.279

02.02.091

CLUTCH SERVOS

Oem Ref. No:
9700514410
0002540247
0002540447
0002953718
0002540747
81307256104

Oil:
Mineral

Vehicle:
MAN
MERCEDES
1840 AXOR NEW MODELL
3340 AXOR



HYDRAULIC
MINERAL
OIL

RK.02.016.P

REPAIR KITS

Oem Ref. No:
9700519742
0002500262



RK.02.109.P



02.276

REPAIR KITS

RK.02.056

Oem Ref. No:
9700519862
4411005312
0015429318



CLUTCH SERVOS

02.02.092

CLUTCH SERVOS

Oem Ref. No:
9700514430
0002540747
2520123727624

Oil:
Hydraulic
Hidrolik

Vehicle:
MERCEDES
NATO



RK.02.016.P

REPAIR KITS

Oem Ref. No:
9700519742
0002500262



RK.02.108.P



02.272

REPAIR KITS

RK.02.056

Oem Ref. No:
9700519862
4411005312
0015429318



02.02.093

CLUTCH SERVOS

Oem Ref. No:
9700514440

Oil:
Hydraulic
Hidrolik

Vehicle:



RK.02.060

REPAIR KITS

Oem Ref. No:
9700519622



RK.02.136



02.276

02.02.094

CLUTCH SERVOS

Oem Ref. No:
9700514460
81307256100
8840164690

Oil:
Hydraulic
Hidrolik

Vehicle:
MAN
NEOPLAN



RK.02.048

REPAIR KITS

Oem Ref. No:
9700519712



RK.02.127



02.279

REPAIR KITS

RK.02.056

Oem Ref. No:
9700519862
4411005312
0015429318



02.02.095

CLUTCH SERVOS

Oem Ref. No:
9700514470

Oil:
Hydraulic
Hidrolik

Vehicle:



RK.02.060

REPAIR KITS

RK.02.136

Oem Ref. No:
9700519622



02.276

02.02.096

CLUTCH SERVOS

Oem Ref. No:
9700514490

Oil:
Hydraulic
Hidrolik

Vehicle:
MAN
MERCEDES



RK.02.048

REPAIR KITS

RK.02.126

REPAIR KITS

RK.02.056

Oem Ref. No:
9700519712



02.276



Oem Ref. No:
9700519862
4411005312
0015429318

02.02.097

CLUTCH SERVOS

Oem Ref. No:
9700514510

Oil:
Hydraulic
Hidrolik

Vehicle:



RK.02.060

REPAIR KITS

RK.02.136

Oem Ref. No:
9700519622



02.276

CLUTCH SERVOS

02.02.098

CLUTCH SERVOS

Oem Ref. No:
9700514530

Oil:
Synthetic
Sentetik

Vehicle:



RK.02.060

REPAIR KITS

RK.02.107

Oem Ref. No:
9700519622



02.279



02.02.099

CLUTCH SERVOS

Oem Ref. No:
9700514550
7C467K626BA
504177095

Oil:
Synthetic
Sentetik

Vehicle:
FORD
IVECO



RK.02.043

REPAIR KITS

RK.02.123

REPAIR KITS

RK.02.148

Oem Ref. No:
9700519842



02.279

Oem Ref. No:
9700519602
5001845590



02.02.100

CLUTCH SERVOS

Oem Ref. No:
9700514570

Oil:
Hydraulic
Hidrolik

Vehicle:



RK.02.029

REPAIR KITS

RK.02.103

Oem Ref. No:
9700519612
81307256091



02.02.276



02.02.101
CLUTCH SERVOS
Oem Ref. No:
9700514610

Oil:
Hydraulic
Hidrolik

Vehicle:

RK.02.029
REPAIR KITS
RK.02.101
Oem Ref. No:
9700519612
81307256091

02.272

02.02.102
CLUTCH SERVOS
Oem Ref. No:
9700514620

Oil:
Hydraulic
Hidrolik

Vehicle:

RK.02.029
REPAIR KITS
RK.02.101
Oem Ref. No:
9700519612
81307256091

02.272

02.02.103
CLUTCH SERVOS
Oem Ref. No:
9700514630

Oil:
Hydraulic
Hidrolik

Vehicle:

RK.02.029
REPAIR KITS
RK.02.104
Oem Ref. No:
9700519612
81307256091

02.279

CLUTCH SERVOS

02.02.104

CLUTCH SERVOS

Oem Ref. No:
9700514640

Oil:
Hydraulic
Hidrolik

Vehicle:



RK.02.060

REPAIR KITS

Oem Ref No:
9700519622



RK.02.107



02279

02.02.105

CLUTCH SERVOS

Oem Ref. No:
9700514220
5010452512

Oil:
Hydraulic
Hidrolik

Vehicle:
RENAULT
PREMIUM/MAGNUM
390/420TI/430/470/530
BMC PRO FATIH
MAN



RK.02.059

REPAIR KITS

Oem Ref. No:
9700519732
5001843797



RK.02.128



02.276

02.02.106

CLUTCH SERVOS

Oem Ref. No:
9700511910
1331770
1747895
1504842
622199AM

Oil:
Hydraulic
Hidrolik

Vehicle:
SCANIA 113
DAF
KOMATSU



RK.02.002

REPAIR KITS

Oem Ref. No:
9700519062
5001832980



RK.02.082



02.272

02.02.107

CLUTCH SERVOS

Oem Ref. No:

9700511540
0002952318
0501006890
0501006695

Oil:

Hydraulic
Hidrolik

Vehicle:

MERCEDES



RK.02.006

REPAIR KITS

Oem Ref. No:

9700519112



RK.02.092



02.279

02.02.108

CLUTCH SERVOS

Oem Ref. No:

9700511810

Oil:

Hydraulic
Hidrolik

Vehicle:



RK.02.012

REPAIR KITS

Oem Ref. No:

9700519502



RK.02.129



02.276

02.02.109

CLUTCH SERVOS

Oem Ref. No:

9700511920
1504843
1521371
1668501
1671953
626639AM

Oil:

Hydraulic
Hidrolik

Vehicle:

VOLVO FH16
DAF
KOMATSU

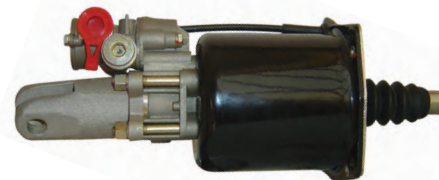

RK.02.002

REPAIR KITS

Oem Ref. No:

9700519062
5001832980



RK.02.082



02.272

CLUTCH SERVOS

02.02.110

CLUTCH SERVOS

Oem Ref. No:
9700511930
360717
1747894
622107AM
1504844

Oil:
Synthetic
Sentetik

Vehicle:
DAF
SCANIA 2 SERIES
KOMATSU



RK.02.002

REPAIR KITS

Oem Ref. No:
9700519062
5001832980



RK.02.082



02.272

02.02.111

CLUTCH SERVOS

Oem Ref. No:
9700511940
1655639
1504845

Oil:
Synthetic
Sentetik

Vehicle:
VOLVO
DAF
KOMATSU



RK.02.002

REPAIR KITS

Oem Ref. No:
9700519062
5001832980



02.272

02.02.112

CLUTCH SERVOS

Oem Ref. No:
9700511950

Oil:
Hydraulic
Hidrolik

Vehicle:



RK.02.009

REPAIR KITS

Oem Ref. No:
9700519442



RK.02.094



02.272

02.02.113

CLUTCH SERVOS

Oem Ref. No:
9700514420
0002540547

Oil:
Mineral

Vehicle:
MERCEDES



RK.02.031.P

REPAIR KITS

Oem Ref. No:
9700519752
9700519872



RK.02.116.P



02.276

02.02.114

CLUTCH SERVOS

Oem Ref. No:
9700514520
7420830800

Oil:
Hydraulic
Hidrolik

Vehicle:
RENAULT



RK.02.015

REPAIR KITS

Oem Ref. No:
9700519522



RK.02.106



02.277

02.02.115

CLUTCH SERVOS

Oem Ref. No:
9700514540
0002541247

Oil:
Hydraulic
Hidrolik

Vehicle:
MERCEDES



RK.02.141

REPAIR KITS

Oem Ref. No:
9700519942



RK.02.142



02.276

REPAIR KITS

RK.02.056

Oem Ref. No:
9700519862
4411005312
0015429318



CLUTCH SERVOS

02.02.116

CLUTCH SERVOS

Oem Ref. No:
9700514590
504177095

Oil:
Hydraulic
Hidrolik

Vehicle:
IVECO



RK.02.043

REPAIR KITS

Oem Ref. No:
9700519842



RK.02.123



02.279

REPAIR KITS

RK.02.148

Oem Ref. No:
9700519602
5001845590



02.02.117

CLUTCH SERVOS

Oem Ref. No:
9700514660
81307256116

Oil:
Hydraulic
Hidrolik

Vehicle:
MAN TGA / TGS / TGX
NEOPLAN
TGS / TGX / DÜZ ŞANZUMAN



RK.02.048.P

REPAIR KITS

Oem Ref. No:
9700519712



RK.02.127.P



02.279

REPAIR KITS

RK.02.056

Oem Ref. No:
9700519862
4411005312
0015429318



02.02.118

CLUTCH SERVOS

Oem Ref. No:
9700511670

Oil:
Hydraulic
Hidrolik

Vehicle:



RK.02.009

REPAIR KITS

Oem Ref. No:
9700519442



RK.02.094



02.276

02.02.119

CLUTCH SERVOS

Oem Ref. No:
9700514800

Oil:
Hydraulic
Hidrolik

Vehicle:



RK.02.029

REPAIR KITS

Oem Ref. No:
9700519612
81307256091



RK.02.112



02.279

REPAIR KITS

RK.02.148

Oem Ref. No:
9700519602
5001845590



02.02.120

CLUTCH SERVOS

Oem Ref. No:
9700514840
5801311227

Oil:
Hydraulic
Hidrolik

Vehicle:
IRISBUS



RK.02.043

REPAIR KITS

Oem Ref. No:
9700519842



RK.02.123



02.279

REPAIR KITS

RK.02.148

Oem Ref. No:
9700519602
5001845590



02.02.121

CLUTCH SERVOS

Oem Ref. No:
9700514820

Oil:
Hydraulic
Hidrolik

Vehicle:



RK.02.029

REPAIR KITS

Oem Ref. No:
9700519612
81307256091



RK.02.127



02.279

REPAIR KITS

RK.02.148

Oem Ref. No:
9700519602
5001845590



CLUTCH SERVOS

02.02.122

CLUTCH SERVOS

Oem Ref. No:
9700514740

Oil:
Hydraulic
Hidrolik

Vehicle:



RK.02.043

REPAIR KITS

Oem Ref. No:
9700519842



RK.02.123



02.279

REPAIR KITS

RK.02.148

Oem Ref. No:
9700519602
5001845590



02.02.123

CLUTCH SERVOS

Oem Ref. No:
9700512260

Oil:
Hydraulic
Hidrolik

Vehicle:
RENAULT
TEMSA



RK.02.004

REPAIR KITS

Oem Ref. No:
9700519102
066873
0002900647



RK.02.088



02.279

REPAIR KITS

RK.02.062

Oem Ref. No:
9700519372



Yumak No	Referance No	Vehicle
02.02.124	9700514170	RENAULT
02.02.125	9700514340	
02.02.126	9700514650	
02.02.127	9700514580	
02.02.128	9700514600	

02.01.001

CLUTCH SERVOS

Oem Ref. No:
VG3200
193581
81307256027

Oil:
Hydraulic
Hidrolik

Vehicle:
MAN 26-230
M90/14.192/12.192/14.136
F8/19.361
33.320/33.365
IVECO



RK.02.018

REPAIR KITS

REPAIR KITS

RK.02.018.10

Oem Ref. No:
193581 / 0051
184613
81307256030



02.01.002

CLUTCH SERVOS

Oem Ref. No:
VG3204
193582
0659807
637208220
637208440

Oil:
Hydraulic
Hidrolik

Vehicle:
DAF 2300 /2500
DAF /LEYLAND 2500
IRISBUS
MAN F80/F81
IVECO



RK.02.019

REPAIR KITS

REPAIR KITS

RK.02.019.10

Oem Ref. No:
183345 / 008



02.01.003

CLUTCH SERVOS

Oem Ref. No:
VG3208
188094
81307256031
81307256032
81307256033

Oil:
Hydraulic
Hidrolik

Vehicle:
IVECO
MAN
F9016.362/16.292/16.332
24.292/24.332/19.462
19.292/19.332



RK.02.020

REPAIR KITS

REPAIR KITS

RK.02.020.10

Oem Ref. No:
188094 / 0051
190586



CLUTCH SERVOS

02.01.004

CLUTCH SERVOS

Oem Ref. No:
VG3229
II141794
81307256051
81307256053
81307256054

Oil:
Hydraulic
Hidrolik

Vehicle:
MAN
F90/F2000/L2000/M2000
19.362/22.462/24.332/
24.292/16.332/16.292/19.332/
22.332/22.362/19.462



RK.02.020

REPAIR KITS

REPAIR KITS

RK.02.020.10

Oem Ref. No:
I88094 / 0051
I90586



02.01.005

CLUTCH SERVOS

Oem Ref. No:
VG3261
II31733
II17464
81307256065

Oil:
Hydraulic
Hidrolik

Vehicle:
MAN
F2000
26-270



RK.02.022

REPAIR KITS

Oem Ref. No:

II31783 / 008
81307256080



02.01.006

CLUTCH SERVOS

Oem Ref. No:
VG3262
II17767
81307256068

Oil:
Hydraulic
Hidrolik

Vehicle:
MAN
L2000/M2000
32-270



RK.02.023

REPAIR KITS

REPAIR KITS

RK.02.023.10

Oem Ref. No:

II17767 / 0051



02.01.008

CLUTCH SERVOS

Oem Ref. No:

VG3264
II35696
98438178

Oil:

Hydraulic
Hidrolik

Vehicle:

DAF/LEYLAND DB250
IRISBUS BUS-EURORIDER
IVECO / SEDDON / ATKINSON
EUROCARGO
180/440120/170
EUROCARGO LIGHT&HEAWY
EUROCARGO MEDIUM
EURO 60/150-A/H
STRALIS



RK.02.036

REPAIR KITS

Oem Ref. No:

II35696 / 008



REPAIR KITS

RK.02.036.10



02.01.010

CLUTCH SERVOS

Oem Ref. No:

VG3213
I92489

Oil:

Hydraulic
Hidrolik

Vehicle:

MAN
F90/F2000/L2000/M2000
19.362/22.462/24.332/
24.292/16.332/16.292/19.332/
22.332/22.362/19.462



RK.02.020

REPAIR KITS

Oem Ref. No:

I88094 / 0051
I90586



REPAIR KITS

RK.02.020.10



02.01.011

CLUTCH SERVOS

Oem Ref. No:

VG3228
II37933

Oil:

Hydraulic
Hidrolik

Vehicle:

MAN



RK.02.020

REPAIR KITS

Oem Ref. No:

I88094 / 0051
I90586



REPAIR KITS

RK.02.020.10



CLUTCH SERVOS

02.01.012

CLUTCH SERVOS

Oem Ref. No:
VG3265
I136373

Oil:
Hydraulic
Hidrolik

Vehicle:
BMC /BUSES/BUS



RK.02.019

REPAIR KITS

REPAIR KITS

RK.02.019.10

Oem Ref. No:
I83345 / 008



02.01.013

CLUTCH SERVOS

Oem Ref. No:
VG3267
I136377

Oil:
Synthetic
Sentetik

Vehicle:
CHRYSLER
ASKAM
ERF -EC SERIES



RK.02.019

REPAIR KITS

REPAIR KITS

RK.02.019.10

Oem Ref. No:
I83345 / 008



02.01.014

CLUTCH SERVOS

Oem Ref. No:
VG3268
I137933

Oil:
Hydraulic
Hidrolik

Vehicle:
MAN
MAZ
105/103/104/107/152/
203/251/4370/533/543



RK.02.020

REPAIR KITS

REPAIR KITS

RK.02.020.10

Oem Ref. No:
I88094 / 0051
I90586



02.01.015
CLUTCH SERVOS
Oem Ref. No:

 VG3269
 I136379
 41035502

Oil:

 Hydraulic
 Hidrolik

Vehicle:

 DAF/LEYLAND DB250
 IRISBUS BUS-EURORIDER
 IVECO / EUROTECH
 EUROCARGO 180/440120/170
 EUROCARGO LIGHT&HEAWY
 EUROCARGO MEDIUM
 EURO 60/150-A/H
 STRALIS

 DOT3
 DOT4
 SAE J1703

RK.02.036
REPAIR KITS
Oem Ref. No:

I135696 / 008

 DOT3
 DOT4
 SAE J1703

REPAIR KITS
RK.02.036.10

02.01.016
CLUTCH SERVOS
Oem Ref. No:

 VG3275
 I137950

Oil:

 Hydraulic
 Hidrolik

Vehicle:

 DOT3
 DOT4
 SAE J1703

RK.02.020
REPAIR KITS
Oem Ref. No:

 I88094 / 0051
 I90586

 DOT3
 DOT4
 SAE J1703

REPAIR KITS
RK.02.020.10

02.01.017
CLUTCH SERVOS
Oem Ref. No:

 VG3276
 I140096F
 5006001558

Oil:

 Hydraulic
 Hidrolik

Vehicle:

 IRISBUS BUS
 IVECO

 DOT3
 DOT4
 SAE J1703

RK.02.022
REPAIR KITS
Oem Ref. No:

I131783 / 008

 DOT3
 DOT4
 SAE J1703

CLUTCH SERVOS

02.01.018

CLUTCH SERVOS

Oem Ref. No:
VG3238
II19612

Oil:
Hydraulic
Hidrolik

Vehicle:
TATRA
420/T815



RK.02.020

REPAIR KITS

REPAIR KITS

RK.02.020.10

Oem Ref. No:
I88094 / 0051
I90586



02.01.019

CLUTCH SERVOS

Oem Ref. No:
VG3285
K0001071

Oil:
Hydraulic
Hidrolik

Vehicle:
DAEWUU-AVIA / AD100



RK.02.018

REPAIR KITS

REPAIR KITS

RK.02.018.10

Oem Ref. No:
I93581 / 0051
I84613



02.01.021

CLUTCH SERVOS

Oem Ref. No:
VG3239
II17770

Oil:
Hydraulic
Hidrolik

Vehicle:



RK.02.020

REPAIR KITS

REPAIR KITS

RK.02.020.10

Oem Ref. No:
I88094 / 0051
I90586



02.01.022 CLUTCH SERVOS

Oem Ref. No: VG3283
K000411

Oil: Hydraulic
Hidrolik

Vehicle:



RK.02.020 REPAIR KITS



Oem Ref. No:
188094 / 0051
190586

REPAIR KITS

RK.02.020.10



02.01.023 CLUTCH SERVOS

Oem Ref. No: VG3284
K000511

Oil: Synthetic
Sentetik

Vehicle:



RK.02.020 REPAIR KITS



Oem Ref. No:
188094 / 0051
190586

REPAIR KITS

RK.02.020.10



02.01.024 CLUTCH SERVOS

Oem Ref. No: VG3221
98420498
984308178
ALTERNATIF
VG3286

Oil: Synthetic
Sentetik

Vehicle: IVECO
SPR1 MEDIUM
IRISBUS /BUS



RK.02.036 REPAIR KITS



Oem Ref. No:
1135696 / 008

REPAIR KITS

RK.02.036.10



CLUTCH SERVOS

02.01.025

CLUTCH SERVOS

Oem Ref. No:

VG3288
41035646
K004296
K004296AT
K004296N03

Oil:

Hydraulic
Hidrolik

Vehicle:

IVECO
IRISBUS EURORIDER



RK.02.036

REPAIR KITS

REPAIR KITS

RK.02.036.10

Oem Ref. No:

1135696 / 008



02.01.026

CLUTCH SERVOS

Oem Ref. No:

VG3289
41035647
K.004297

Oil:

Hydraulic
Hidrolik

Vehicle:

IVECO STRALIS



RK.02.036

REPAIR KITS

REPAIR KITS

RK.02.036.10

Oem Ref. No:

1135696 / 008



02.01.027

CLUTCH SERVOS

Oem Ref. No:

VG3277
1140098F

Oil:

Hydraulic
Hidrolik

Vehicle:



RK.02.018

REPAIR KITS

REPAIR KITS

RK.02.018.10

Oem Ref. No:

193581 / 0051
184613



02.01.028

CLUTCH SERVOS

Oem Ref. No:
VG3278

Oil:
Hydraulic
Hidrolik

Vehicle:



RK.02.019

REPAIR KITS

REPAIR KITS

RK.02.019.10

Oem Ref. No:
I83345 / 008



02.01.029

CLUTCH SERVOS

Oem Ref. No:
VG3279

Oil:
Synthetic
Sentetik

Vehicle:



RK.02.020

REPAIR KITS

REPAIR KITS

RK.02.020.10

Oem Ref. No:
I88094 / 0051
I90586



02.01.030

CLUTCH SERVOS

Oem Ref. No:
VG3281

Oil:
Synthetic
Sentetik

Vehicle:



RK.02.022

REPAIR KITS

Oem Ref. No:

I131783 / 008



CLUTCH SERVOS

02.01.031

CLUTCH SERVOS

Oem Ref. No:
VG3211
I93585

Oil:
Hydraulic
Hidrolik

Vehicle:



RK.02.018

REPAIR KITS

REPAIR KITS

RK.02.018.10

Oem Ref. No:
I93581 / 0051
I84613



02.01.034

CLUTCH SERVOS

Oem Ref. No:
VG3222

Oil:
Hydraulic
Hidrolik

Vehicle:



RK.02.018

REPAIR KITS

REPAIR KITS

RK.02.018.10

Oem Ref. No:
I93581 / 0051
I84613



02.01.035

CLUTCH SERVOS

Oem Ref. No:
VG3227

Oil:
Hydraulic
Hidrolik

Vehicle:



RK.02.036

REPAIR KITS

REPAIR KITS

RK.02.036.10

Oem Ref. No:
I135696 / 008



02.01.037

CLUTCH SERVOS

Oem Ref. No:
VG3234

Oil:
Hydraulic
Hidrolik

Vehicle:
STEYR
MAN
MERCEDES



RK.02.018

REPAIR KITS

REPAIR KITS

RK.02.018.10

Oem Ref. No:
I93581 / 0051
I84613



RK.02.034

REPAIR KITS

Oem Ref. No:

Oil

Vehicle

Synthetic Sentetik

FOR
VG3304
VG3306



RK.02.025

REPAIR KITS

Oem Ref. No:

Oil

Vehicle

II14195 / 008

FOR
VG3361
0002951518



CLUTCH SERVOS

02.03.001 - 02.03.002

CLUTCH SERVOS

Oem Ref. No:

APGA1613
3308413
1573173
1505257
1504976
APGA1605
9964739
63877S91
Y00144411

Oil:

Hydraulic
Hidrolik

Vehicle:

MERCEDES
VOLVO
DAF
IVECO
FODEN
BEDFORD
BMC FATIH
DODGE
FORD



RK.02.017

REPAIR KITS

Oem Ref. No:

APGA29069
GA29317
91090744



02.04.001

CLUTCH SERVOS

Oem Ref. No:

622107
1504844
360717
360919
622109A
1747894

Oil:
Hydraulic
Hidrolik

Vehicle:

SCANIA

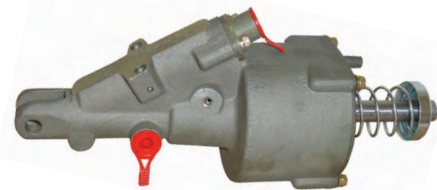

RK.02.049

REPAIR KITS

Oem Ref. No:

550453
550422
550451



02.04.002

CLUTCH SERVOS

Oem Ref. No:

1421186
1513715
1513717
1367453
629683
1469161
1454590
513717
625359

Oil:
Hydraulic
Hidrolik

Vehicle:

SCANIA
3-4 SERIES
91-114
124-144



RK.02.045

REPAIR KITS

Oem Ref. No:

628131
1484715



02.04.004

CLUTCH SERVOS

Oem Ref. No:

20524584
8171720
629276
628492
1672129
KV25013A1
9700518210

Oil:

Hydraulic
Hidrolik

Vehicle:

VOLVO
FM
NH
FH 12-16
BUS
TRUCK



RK.02.053

REPAIR KITS

Oem Ref. No:

85102142
3093100
3093098
RKV25003

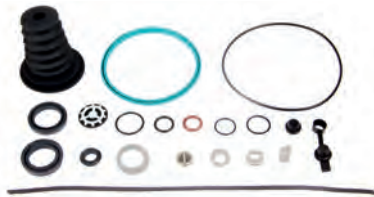

02.04.005

CLUTCH SERVOS

Oem Ref. No:

1443530
1443550
628275
1346864
622508

Oil:

Hydraulic
Hidrolik

Vehicle:

SCANIA



RK.02.046

REPAIR KITS

Oem Ref. No:

1348878



02.04.006

CLUTCH SERVOS

Oem Ref. No:

622190
374116

Oil:

Hydraulic
Hidrolik

Vehicle:

SCANIA
3-4 SERIES
91-114
124-144



RK.02.050

REPAIR KITS

Oem Ref. No:

550465
625282
625283am
550466
625285
550467



CLUTCH SERVOS

02.04.007

CLUTCH SERVOS

Oem Ref. No:
628036
1438606

Oil:
Hydraulic
Hidrolik

Vehicle:
DAF



RK.02.040

REPAIR KITS

Oem Ref. No:
1443527
1348880
626790
1443526
628306
1348878



02.04.008

CLUTCH SERVOS

Oem Ref. No:
628258
1443523
1397121

Oil:
Synthetic
Sentetik

Vehicle:
DAF



RK.02.040

REPAIR KITS

Oem Ref. No:
1443527
1348880
626790
1443526
628306
628305
1348878



02.04.009

CLUTCH SERVOS

Oem Ref. No:
628259
1443522
9700518090
1397120

Oil:
Synthetic
Sentetik

Vehicle:
DAF



RK.02.040

REPAIR KITS

Oem Ref. No:
1443527
1348880
626790
1443526
628306
628305
1348878



02.04.010
CLUTCH SERVOS

Oem Ref. No:
628260
1443524

Oil:
Hydraulic
Hidrolik

Vehicle:
DAF

RK.02.040
REPAIR KITS

Oem Ref. No:
1443527
1348880
626790
1443526
628306
1348878

02.04.012
CLUTCH SERVOS

Oem Ref. No:
628448
1450047

Oil:
Hydraulic
Hidrolik

Vehicle:
DAF

RK.02.040
REPAIR KITS

Oem Ref. No:
1443527
1348880
626790
1443526
628306
1348878

02.04.016
CLUTCH SERVOS

Oem Ref. No:
625586
81307256051
81307256053
81307256093

Oil:
Hydraulic
Hidrolik

Vehicle:
MAN

RK.02.073
REPAIR KITS

Oem Ref. No:
81307256061



CLUTCH SERVOS

02.04.018

CLUTCH SERVOS

Oem Ref. No:
626162
500244402

Oil:
Hydraulic
Hidrolik

Vehicle:
RENAULT V.I.



RK.02.063

REPAIR KITS

Oem Ref. No:
626729
5001843783

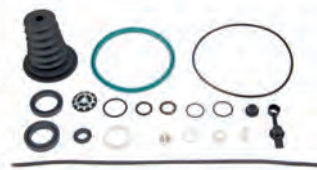

02.05.002

CLUTCH SERVOS

Oem Ref. No:
1655435
1668501
626639AM
1671953
1521371
1521372
1504843

Oil:
Hydraulic
Hidrolik

Vehicle:
VOLVO



RK.02.052

REPAIR KITS

Oem Ref. No:
270586
3093099
3093100
627366
627182
622095
627619
627618



02.05.003

CLUTCH SERVOS

Oem Ref. No:
1526523
1673067
626392AM
1655639
276321
267532
1504845
8112202

Oil:
Hydraulic
Hidrolik

Vehicle:
VOLVO



RK.02.051

REPAIR KITS

Oem Ref. No:
85102140
271194
626703
3095041
273447



02.05.004
CLUTCH SERVOS
Oem Ref. No:

628277
1346866
626708
626786
1241256
289295
1443521
1340024

Oil:

Hydraulic
Hidrolik

Vehicle:

DAF
LEYLAND



Ø 80 mm

RK.02.047
REPAIR KITS
Oem Ref. No:

1443525
628304
626788
627030
12911857

02.05.005
CLUTCH SERVOS
Oem Ref. No:

628276-626785
622501-626642
1443520
628275
626580
1337007
1242616
1346865

Oil:

Hydraulic
Hidrolik

Vehicle:

DAF
LEYLAND



Ø 80 mm

RK.02.047
REPAIR KITS
Oem Ref. No:

1443525
628304
626788

02.05.006
CLUTCH SERVOS
Oem Ref. No:

3192126
628493
629277
8171721
20524585

Oil:

Hydraulic
Hidrolik

Vehicle:

VOLVO

RK.02.053
REPAIR KITS
Oem Ref. No:

85102142
3093100
3093098
RKV25003
628476



CLUTCH SERVOS

02.05.007

CLUTCH SERVOS

Oem Ref. No:

1443531
1346863
628450
626783
626400
1327940

Oil:

Hydraulic
Hidrolik

Vehicle:

DAF
CF75 / 85
F95 / XF95
95XF530
LEYLAND



RK.02.046

REPAIR KITS

Oem Ref. No:

1348878



02.05.008

CLUTCH SERVOS

Oem Ref. No:

622199AM
1331770
1747895
0371612
1504842
628277

Oil:

Hydraulic
Hidrolik

Vehicle:

SCANIA
DAF



RK.02.050

REPAIR KITS

Oem Ref. No:

550465
625282
625283am
550466
625285
550467



02.05.009

CLUTCH SERVOS

Oem Ref. No:

622504
ACU8944
1443520
1346865

Oil:

Hydraulic
Hidrolik

Vehicle:

DAF
65CF



RK.02.065

REPAIR KITS

Oem Ref. No:

1291857



02.05.016
CLUTCH SERVOS

Oem Ref. No:
622502
1752011622

Oil:
Hydraulic
Hidrolik

Vehicle:
SISU

RK.02.068
REPAIR KITS

Oem Ref. No:
3001942
622522
1751800231

02.05.019
CLUTCH SERVOS

Oem Ref. No:
625384
5010244208

Oil:
Hydraulic
Hidrolik

Vehicle:
RENAULT V.I.

RK.02.071
REPAIR KITS

Oem Ref. No:
5001843793
626731AM

02.05.020
CLUTCH SERVOS

Oem Ref. No:
626853
5010245752

Oil:
Hydraulic
Hidrolik

Vehicle:
RENAULT
Ø 80 mm

RK.02.071
REPAIR KITS

Oem Ref. No:
5001843793
626731AM



CLUTCH SERVOS

02.05.021

CLUTCH SERVOS

Oem Ref. No:

624199
1337966
SV1036

Oil:

Hydraulic
Hidrolik

Vehicle:

HYUNDAI
SCANIA GPR 93/113
3 SERIES

Ø 100 mm



RK.02.050

REPAIR KITS

Oem Ref. No:

550465
625282



02.05.022

CLUTCH SERVOS

Oem Ref. No:

628494
8171700
8171722

Oil:

Hydraulic
Hidrolik

Vehicle:

VOLVO
PREVOST



RK.02.053

REPAIR KITS

Oem Ref. No:

85102142
3093100
3093098
RKV25003

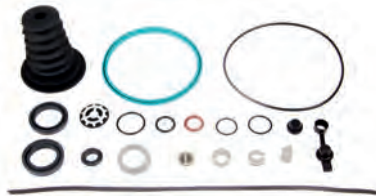

02.05.023

CLUTCH SERVOS

Oem Ref. No:

629479
626397

Oil:

Hydraulic
Hidrolik

Vehicle:

Renault V.I.
FODEN



RK.02.047

REPAIR KITS

Oem Ref. No:

1443525
628304
626788
627030



02.07.001
CLUTCH SERVOS
Oem Ref. No:
Oil:

 Hydraulic
Hidrolik

Vehicle:

RK.02.151
REPAIR KITS
Oem Ref. No:

02.07.002
CLUTCH SERVOS
Oem Ref. No:
Oil:

 Hydraulic
Hidrolik

Vehicle:

RK.02.151
REPAIR KITS
Oem Ref. No:

02.06.001
HYDRAIR CLUTCH SERVO
Oem Ref. No:

 0002570177
321027001
0002953418
321023001

Oil:

DOT 4

Vehicle:

MERCEDES

02.06.002
HYDRAIR CLUTCH SERVO
Oem Ref. No:

 0002954018
321025001
0002570277

Oil:

PENTOSIL

Vehicle:

MERCEDES AXOR 3028



CLUTCH SERVOS

02.05.028

CLUTCH SERVOS

Oem Ref. No:

1523399
1784480
1927825
1000178631AM

Oil:

Ø 125 mm

Vehicle:

SCANIA P-G-R-T SERIES



RK.02.155

REPAIR KITS

Oem Ref. No:

1927825S
1000178631SP1AM



13.05.001

GEAR LEVER ACTUATOR

Oem Ref. No:

627496AM
81326056111
81326556128

Oil:

Pentosil

Vehicle:

MAN TGA

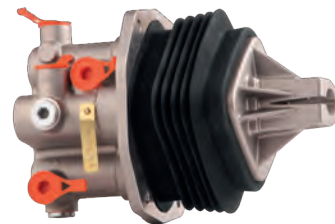

RK.13.002

FULL REPAIR KITS

Oem Ref. No:

628072AM
81326556157

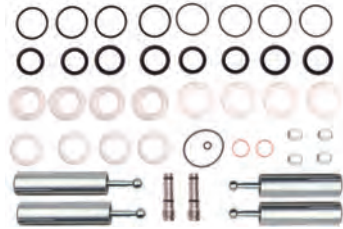

RK.13.001

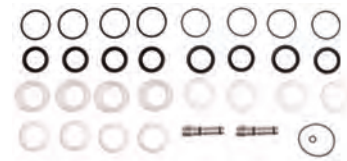

REPAIR KITS

13.05.002
GEAR LEVER ACTUATOR

Oem Ref. No:
626321AM
0002607198
0002604098

Oil:
DOT3
DOT4

Vehicle:
Mercedes
Actros-Atego Schwer

RK.13.003
FULL REPAIR KITS

Oem Ref. No:

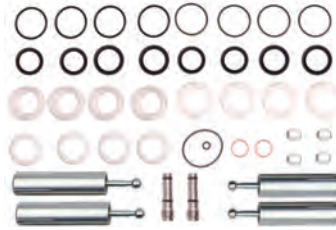
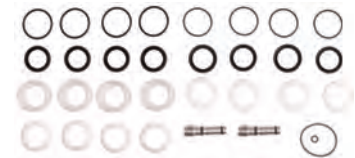
RK.13.004

REPAIR KITS

13.05.003
GEAR LEVER ACTUATOR

Oem Ref. No:
630388AM
0002606198
0002607998

Oil:
PENTOSIL

Vehicle:
Mercedes
Actros-Atego Schwer
Axor

RK.13.005
FULL REPAIR KITS

Oem Ref. No:

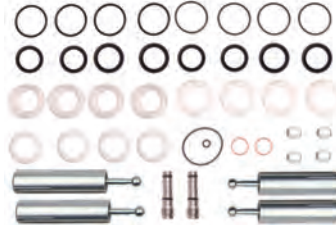
RK.13.006

REPAIR KITS

13.05.004
GEAR LEVER ACTUATOR

Oem Ref. No:
626661AM
0002604198
0002607298

Oil:
DOT3-DOT4

Vehicle:
Mercedes
Actros-Atego Schwer
Axor

RK.13.012
FULL REPAIR KITS

Oem Ref. No:

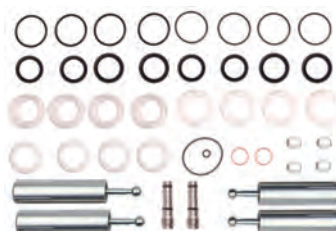
RK.13.011

REPAIR KITS

CLUTCH SERVOS

13.05.005

GEAR LEVER ACTUATOR

Oem Ref. No:
626662AM
0002604298
0002605098

Oil:
DOT3-DOT4

Vehicle:
SCANIA P-G-R-T SERIES



RK.13.014

REPAIR KITS

Oem Ref. No:

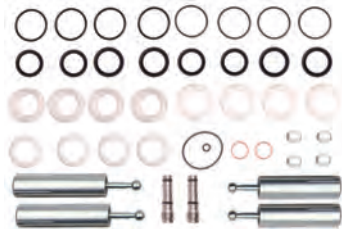

RK.13.013

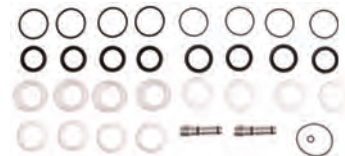

13.05.006

GEAR LEVER ACTUATOR

Oem Ref. No:
629582AM
0002605998
0002607898

Oil:
Pentosil

Vehicle:



RK.13.007

FULL REPAIR KITS

Oem Ref. No:

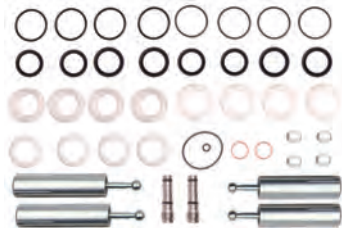

RK.13.008

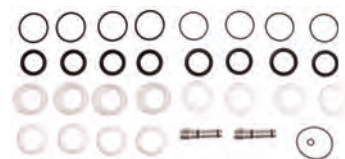

REPAIR KITS

13.05.007

GEAR LEVER ACTUATOR

Oem Ref. No:
629862AM
0002606098

Oil:
PENTOSIL

Vehicle:



RK.13.009

FULL REPAIR KITS

Oem Ref. No:

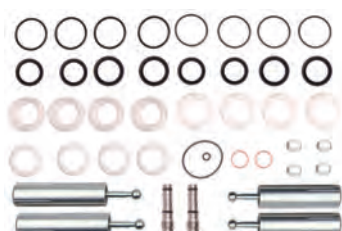

RK.13.010

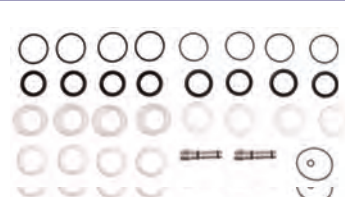

REPAIR KITS

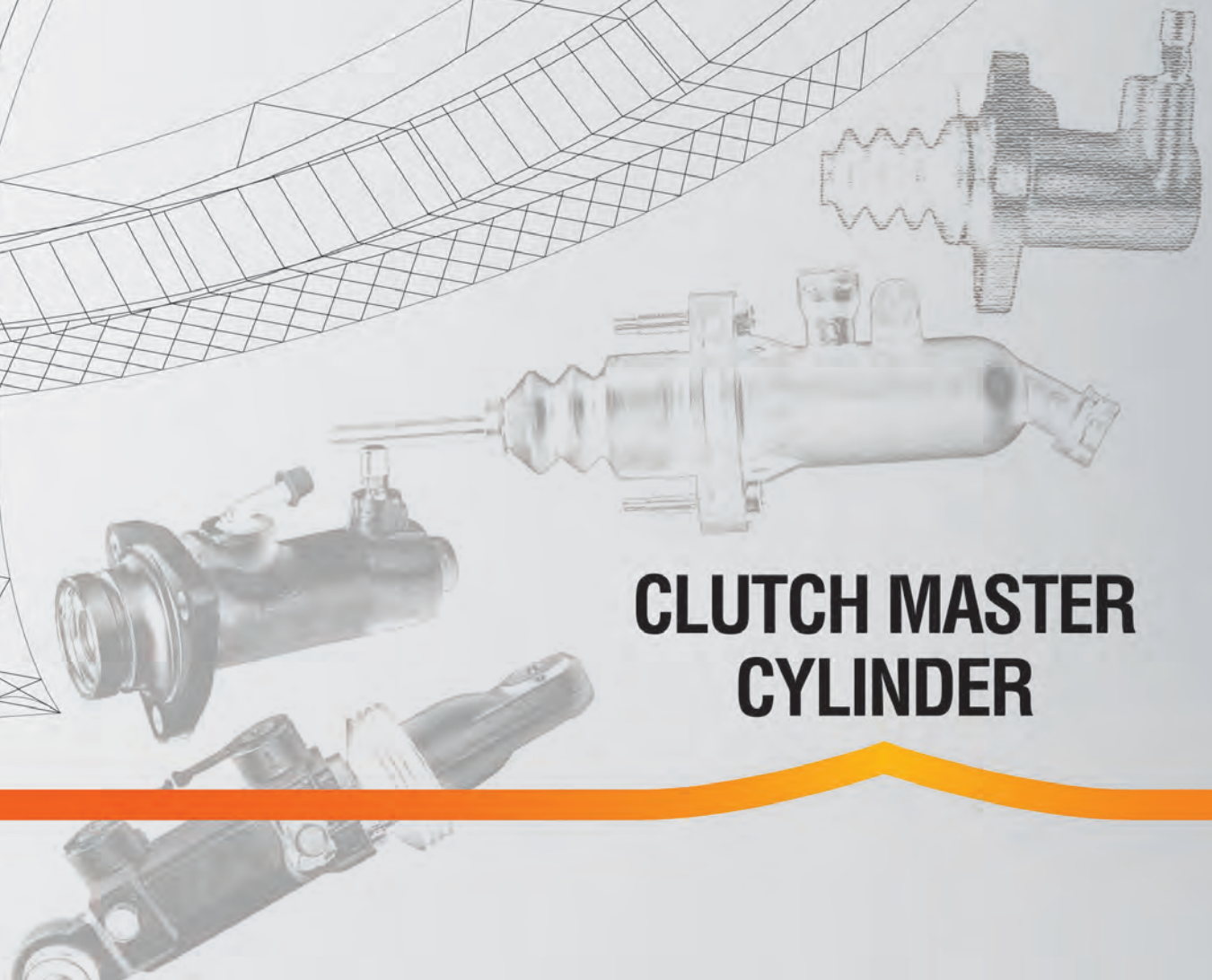
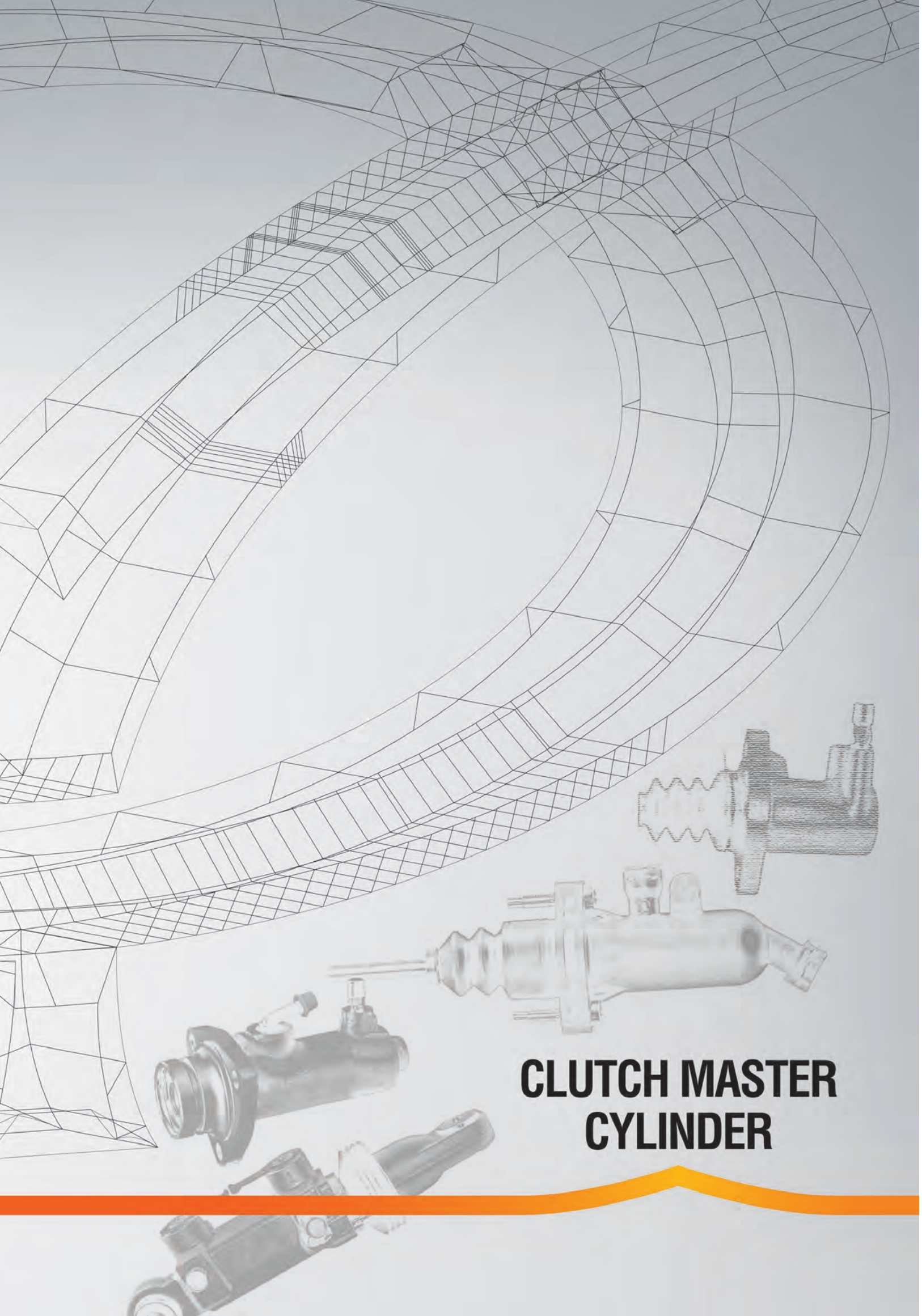

CLUTCH MASTER CYLINDER



MERCEDES 02 / 106

MAN 110 / 218

VOLVO 222 / 319

SCANIA 322 / 356

DAF 360 / 410

RENAULT 414 / 467

IVECO 470 / 521

**FORD&BMC
CUMMINS** 524 / 556

DEUTZ 560 / 573

MAGIRUS 576 / 585

IKARUS 588 / 591

**OTHER
BRANDS** 594 / 620

GEARS 624 / 531

**CLUTCH
SERVO** 634 / 695

VALVES 698 / 755

**OTHER
PARTS** 758 / 765

09.01.001

CLUTCH SERVOS

Oem Ref. No:

0012950307
0012950407
0012955307
0012958007
KN3805J1
0002957907
0012958807
S6197
Ø 38,1 mm

Oil:

Hydraulic
Hidrolik

Vehicle:

MERCEDES
303 BUS



RK.09.012

REPAIR KITS



Oem Ref. No:

0002900911
RK38816K

Ø 38,1 mm

09.01.002

CLUTCH SERVOS

Oem Ref. No:

0012956006
KG239517
S5185

Oil:

Vehicle:

MERCEDES



Ø 23,81 mm

RK.09.014

REPAIR KITS



Oem Ref. No:

0002904667
RK23714

09.01.004

CLUTCH SERVOS

Oem Ref. No:

0012952906
0002956806
KG239513
S5185

Oil:

Vehicle:

MERCEDES



Ø 23,81 mm

RK.09.014

REPAIR KITS



Oem Ref. No:

0002904667
RK23714

CLUTCH MASTER CYLINDER

09.01.005

CLUTCH SERVOS

Oem Ref. No:
KN2802201
0012959607
0012954507
0012955407
S6486

Oil:

Vehicle:
MERCEDES



Ø 28,57 mm

RK.09.015

REPAIR KITS



Oem Ref. No:

RK28813K
0005863529
0002902467
0002904567

09.01.006

CLUTCH SERVOS

Oem Ref. No:
0002606357
0022950207
0012959707
0012958607
0012958507
KN3301D1
S6578

Oil:

Vehicle:
MERCEDES



Ø 33,34 mm

RK.09.084

REPAIR KITS



Oem Ref. No:

0002900511
RK 33801K

09.01.007

CLUTCH SERVOS

Oem Ref. No:
0012959506
0012959306
0022950406
0022950706
KG20001010

Oil:

Vehicle:
MERCEDES
ATEGO



RK.09.039



Oem Ref. No:

09.01.008

CLUTCH SERVOS

Oem Ref. No:
0012957406
KG2201911

Oil:

Vehicle:
MERCEDES



RK.09.018

REPAIR KITS



Oem Ref. No:

RK19799
RK22757
0002901212

09.01.009

CLUTCH SERVOS

Oem Ref. No:
0012953006
KG260411
S5373

Oil:

Vehicle:
MERCEDES
1928/2628/1628
3836/3036/3236



Ø 26,99 mm

RK.09.013

REPAIR KITS



Oem Ref. No:

RK26504
0005866029

09.01.010

CLUTCH SERVOS

Oem Ref. No:
KN380532
0012954407
S6418

Oil:

Vehicle:
MERCEDES



Ø 31,75 mm

RK.09.019

REPAIR KITS



Oem Ref. No:

0002901211
RK31806K

CLUTCH MASTER CYLINDER

09.01.011

CLUTCH SERVOS

Oem Ref. No:
0014306001
0014306801
0024308801
H3893300
S5019

Oil:

Vehicle:
MERCEDES



RK.09.049

REPAIR KITS

Oem Ref. No:



09.01.012

CLUTCH SERVOS

Oem Ref. No:
81307166043

Oil:

Vehicle:
MAN



RK.09.045

REPAIR KITS

Oem Ref. No:



09.01.014

CLUTCH SERVOS

Oem Ref. No:
0012959106
KG2000108

Oil:

Vehicle:
MERCEDES
AXOR 3028



RK.09.053

REPAIR KITS

Oem Ref. No:



09.01.015

CLUTCH SERVOS

Oem Ref. No:
81307166044
S5329

Oil:

Vehicle:



RK.09.046

REPAIR KITS

Oem Ref. No:



09.01.016

CLUTCH SERVOS

Oem Ref. No:
0002958706
0002955006
0002956006
0002956606
0002957706
0002957806
0012951506

HF17001
H17853101
S5207

Vehicle:



Ø 17,46 mm - Ø 20,64 mm

RK.09.047

REPAIR KITS

Oem Ref. No:

0005864729
RK1787



09.01.017

CLUTCH SERVOS

Oem Ref. No:
0002958307

Oil:

Vehicle:



RK.09.055

REPAIR KITS

Oem Ref. No:



CLUTCH MASTER CYLINDER

09.01.019

CLUTCH SERVOS

Oem Ref. No:
KG260211

Oil:

Vehicle:



RK.09.056

REPAIR KITS



Oem Ref. No:

09.01.020

CLUTCH SERVOS

Oem Ref. No:
0014307901
0024302101
0024308401
H3872104
S5249
S406

Oil:

Vehicle:



Ø 38,1 mm

RK.09.057

REPAIR KITS



Oem Ref. No:

0005864843
0015860243
RK3857

09.01.021

CLUTCH SERVOS

Oem Ref. No:
0004308501

Oil:

Vehicle:



RK.09.058

REPAIR KITS



Oem Ref. No:

RK31540

09.01.022

CLUTCH SERVOS

Oem Ref. No:
81307156135
KG2303002
S5571

Oil:

Vehicle:
MAN



Ø 24 mm

RK.09.059

REPAIR KITS



Oem Ref. No:

81307156113
RK23722

09.01.023

CLUTCH SERVOS

Oem Ref. No:
81307156119
KG2302701

Oil:

Vehicle:
MAN



Ø 24 mm

RK.09.052

REPAIR KITS



Oem Ref. No:

625976AM
81307153138
81307156113
RK23722

09.01.025

CLUTCH SERVOS

Oem Ref. No:
0074202118
N24802C1
0002960107
4700125202
0064201518

Oil:

Vehicle:
MERCEDES



S6284
Ø 24/34 mm

RK.09.060

REPAIR KITS



Oem Ref. No:

0025865542
RK2413

CLUTCH MASTER CYLINDER

09.01.026

CLUTCH SERVOS

Oem Ref. No:
0022951006
KG2000342

Oil:

Vehicle:
MERCEDES
ATEGO
AXOR 3028-3340



RK.09.061

REPAIR KITS

Oem Ref. No:



09.01.027

CLUTCH SERVOS

Oem Ref. No:
0012603463
626597AM

Oil:

Vehicle:
MERCEDES



RK.09.054

REPAIR KITS

Oem Ref. No:



09.01.029

CLUTCH SERVOS

Oem Ref. No:
8172824
2055387
KG2801942
205535588
20835246
3192996

Oil:

Vehicle:
VOLVO FH 12 - 16
FM 9 - 12
NH 9 - 12
12/340



RK.09.085

REPAIR KITS

Oem Ref. No:



09.01.031

CLUTCH SERVOS

Oem Ref. No:
0002956706
KG340102
0012955506
0002955606

Oil:

Vehicle:
MERCEDES
303 BUS



S5307
Ø 34,92 mm

RK.09.063

REPAIR KITS

Oem Ref. No:



09.01.032

CLUTCH SERVOS

Oem Ref. No:
81307156051
81307156037
81307156092
02505616
KG340101

Oil:

Vehicle:
MAN BUS
IVECO



S5307
Ø 34,92 mm

RK.09.063

REPAIR KITS

Oem Ref. No:



09.01.033

CLUTCH SERVOS

Oem Ref. No:
KN3801735
1506121
1754943
1545626
506121
545626
1764082

Oil:

Vehicle:
SCANIA 4 SERIES
94-114-124-144-164
SCANIA P.G.R.T.
(G-420) (R-500)
230-270-310-340-380
420-470-500



RK.09.043

REPAIR KITS

Oem Ref. No:



CLUTCH MASTER CYLINDER

09.01.034

CLUTCH SERVOS

Oem Ref. No:

627946
532517
1532717
1756460

Oil:

Vehicle:

SCANIA 4 SERIES
94-114-124-144-164
SCANIA P.G.R.T.
(G-420) (R-500)
230-270-310-340-380
420-470-500



RK.09.043

REPAIR KITS

Oem Ref. No:



09.01.035

CLUTCH SERVOS

Oem Ref. No:

0012601863
0022600663
629614AM

Oil:

Vehicle:

MAN



RK.09.045

REPAIR KITS

Oem Ref. No:



09.01.036

CLUTCH SERVOS

Oem Ref. No:

KN25020
B142037645
S6167
02477718

Oil:

Vehicle:

SCANIA



Ø 25,40 mm

RK.09.065

REPAIR KITS

Oem Ref. No:



09.01.038

CLUTCH SERVOS

Oem Ref. No:
0012954006
KG1904612

Oil:

Vehicle:
MERCEDES



RK.09.066

REPAIR KITS

Oem Ref. No:



09.01.039

CLUTCH SERVOS

Oem Ref. No:
0012955206
0012959606
KG19007201
S5421

Oil:

Vehicle:
MERCEDES



Ø 19,05 mm

RK.09.067

REPAIR KITS

Oem Ref. No:

0002902312
RK197006



09.01.040

CLUTCH SERVOS

Oem Ref. No:
0022950707
KN28027A1
0012954007
0012955807

Oil:

Vehicle:
MERCEDES
LK/LN2



S6469
Ø 28,57 mm

RK.09.068

REPAIR KITS

Oem Ref. No:

RK 28812K



CLUTCH MASTER CYLINDER

09.01.042

CLUTCH SERVOS

Oem Ref. No:
KG2394112

Oil:

Vehicle:



RK.09.069

REPAIR KITS

Oem Ref. No:



09.01.043

CLUTCH SERVOS

Oem Ref. No:
KN3406E66

Oil:

Vehicle:



Ø 34,92 mm

RK.09.070

REPAIR KITS

Oem Ref. No:



09.01.044

CLUTCH SERVOS

Oem Ref. No:
KG2670311

Oil:

Vehicle:



RK.09.071

REPAIR KITS

Oem Ref. No:



09.02.002

CLUTCH SERVOS

Oem Ref. No:

KG2801411
1669488
1620462
1581209
KG280911
1614351
8126730

Oil:

Vehicle:

VOLVO



RK.09.016(AL)

REPAIR KITS



Oem Ref. No:

RK28710
273660
3094523
2711067
6889681
3094730

09.02.003

CLUTCH SERVOS

Oem Ref. No:

KG2302112
0012955306
0012957406
0012959706
0012952506
3882957206
166070170

Oil:

Vehicle:

MERCEDES



RK.09.023

REPAIR KITS



Oem Ref. No:

0002900512
RK 23716

09.02.006

CLUTCH SERVOS

Oem Ref. No:

KG2801201
1628218
S5547

Oil:

Vehicle:

VOLVO



Ø 28,57 mm

RK.09.073

REPAIR KITS



Oem Ref. No:

RK2870

CLUTCH MASTER CYLINDER

09.03.007

CLUTCH SERVOS

Oem Ref. No:

KG259514
355973
292962
S5315

Oil:

Vehicle:

SCANIA 92/112 SERIES



Ø 25,40 mm

RK.09.074

REPAIR KITS



Oem Ref. No:

639088
RK25705

09.04.002

CLUTCH SERVOS

Oem Ref. No:

626761AM
1348734

Oil:
Ø24

Vehicle:

DAF



RK.09.037

REPAIR KITS



Oem Ref. No:

1373533
627202AM
625445AM

09.04.003

CLUTCH SERVOS

Oem Ref. No:

626762AM
1348735
1395485
1334482

Oil:

Vehicle:

DAF



RK.09.036

REPAIR KITS



Oem Ref. No:

1373532
1357761

09.04.004

CLUTCH SERVOS

Oem Ref. No:
KG25000102
096392
395161
S5171

Oil:

Vehicle:
DAF



Ø 25,4 mm

RK.09.042

REPAIR KITS



Oem Ref. No:

1237489
RK25717

09.04.005

CLUTCH SERVOS

Oem Ref. No:
323760AM
1348733
1339412
1313142
1298753
1265209
626760

Oil:

Vehicle:
DAF



Ø 26 mm

RK.09.072

REPAIR KITS



Oem Ref. No:

1373531
627200

09.04.006

CLUTCH SERVOS

Oem Ref. No:
625826AM
ACHD274

Oil:
Ø26

Vehicle:
LEYLAND



RK.09.075

REPAIR KITS



Oem Ref. No:

626608AM
624262AM

CLUTCH MASTER CYLINDER

09.05.001

CLUTCH SERVOS

Oem Ref. No:
627233AM

Oil:

Vehicle:



RK.09.011

REPAIR KITS

Oem Ref. No:



09.05.002

CLUTCH SERVOS

Oem Ref. No:
1361136
KG25000402

Oil:

Vehicle:
SCANIA



RK.09.024

REPAIR KITS

Oem Ref. No:

550423
550464



09.05.010

CLUTCH SERVOS

Oem Ref. No:
626169AM
625536AM

Oil:

Vehicle:
ERF



REPAIR KITS

Oem Ref. No:

09.06.002

CLUTCH SERVOS

Oem Ref. No:
81307166082
KN28014C1

Oil:

Vehicle:
MAN



RK.09.081

REPAIR KITS



Oem Ref. No:

09.06.004

CLUTCH SERVOS

Oem Ref. No:
81307166020
KN28013A1

Oil:

Vehicle:
MAN



RK.09.082

REPAIR KITS



Oem Ref. No:

09.07.001

CLUTCH SERVOS

Oem Ref. No:
623104AM
5000877187

Oil:
Ø26

Vehicle:
RENAULT



RK.09.029

REPAIR KITS



Oem Ref. No:

5000803664

CLUTCH MASTER CYLINDER

09.07.002

CLUTCH SERVOS

Oem Ref. No:
623105AM
5000877188

Oil:
Ø28

Vehicle:
RENAULT



RK.09.030

REPAIR KITS

Oem Ref. No:



09.07.003

CLUTCH SERVOS

Oem Ref. No:
623106AM
5000792359

Oil:
Ø26

Vehicle:
RENAULT



RK.09.031

REPAIR KITS

Oem Ref. No:

626243AM



09.07.004

CLUTCH SERVOS

Oem Ref. No:
626159AM
5001834842
5010260052
KG2802101

Oil:
Ø28

Vehicle:
RENAULT



RK.09.032

REPAIR KITS

Oem Ref. No:

5001834844
626163



09.07.005

CLUTCH SERVOS

Oem Ref. No:
5010251357
624248AM

Oil:
28

Vehicle:
RENAULT



RK.09.031

REPAIR KITS



Oem Ref. No:
626165AM

09.09.001

CLUTCH SERVOS

Oem Ref. No:
KG310601
4853408
386090
1422721
0204162084

Oil:

Vehicle:
IVECO
EURO CARGO
EUROTECH
EUROSTAR



RK.09.076

REPAIR KITS



Oem Ref. No:

09.09.003

CLUTCH SERVOS

Oem Ref. No:
0024301401
0024304101

Oil:

Vehicle:
MERCEDES



RK.09.077

REPAIR KITS



Oem Ref. No:

CLUTCH MASTER CYLINDER

09.09.004

CLUTCH SERVOS

Oem Ref. No:
9K1591

Oil:

Vehicle:



RK.09.078

REPAIR KITS

Oem Ref. No:



09.09.006

CLUTCH SERVOS

Oem Ref. No:
FD2704
5T6521

Oil:

Vehicle:
CAT



RK.09.079

REPAIR KITS

Oem Ref. No:



09.09.009

CLUTCH SERVOS

Oem Ref. No:
KG2301711
42063311
S5161

Oil:

Vehicle:
IVECO
TPA



Ø 23,81 mm

RK.09.080

REPAIR KITS

Oem Ref. No:

8124544
RK23711



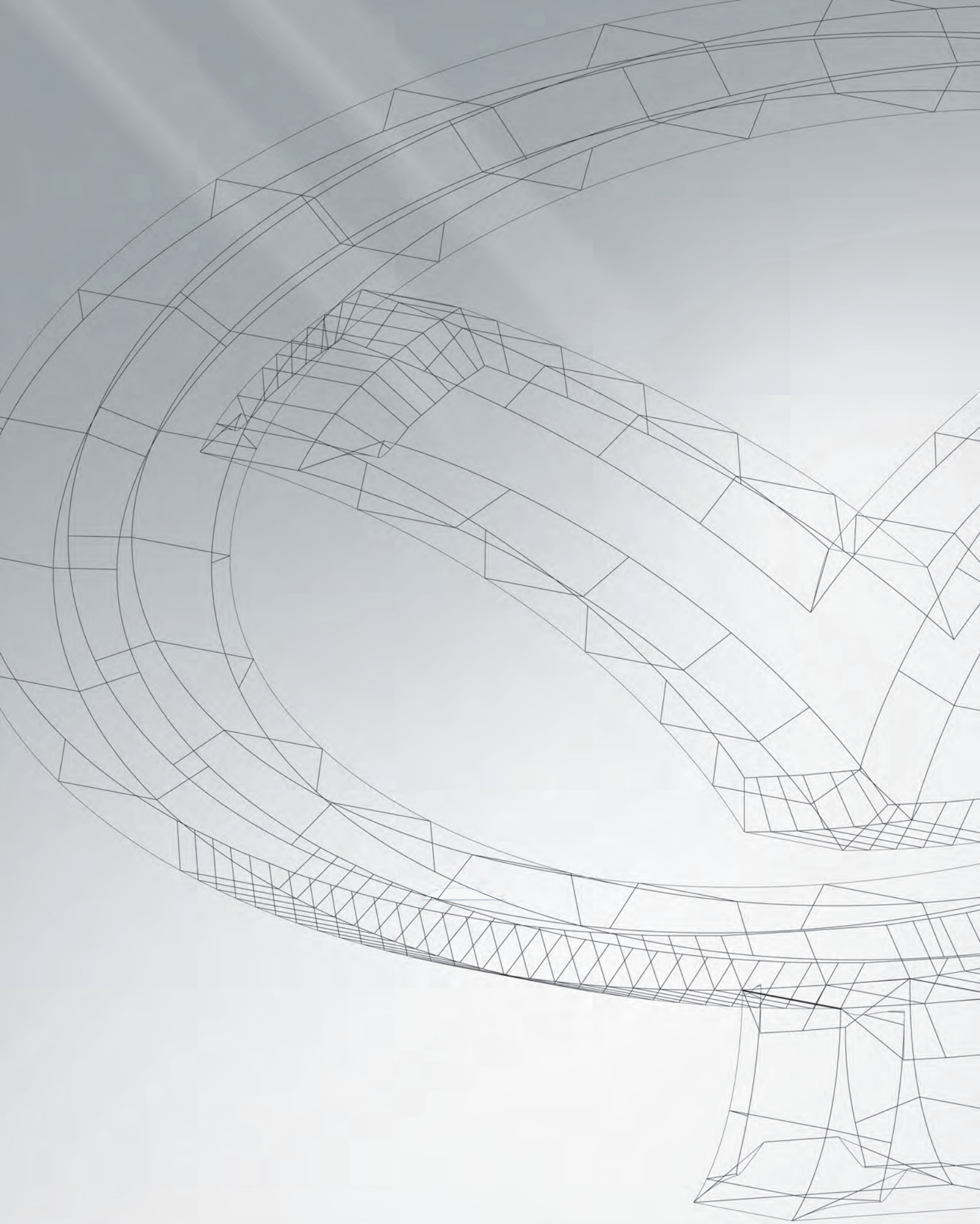

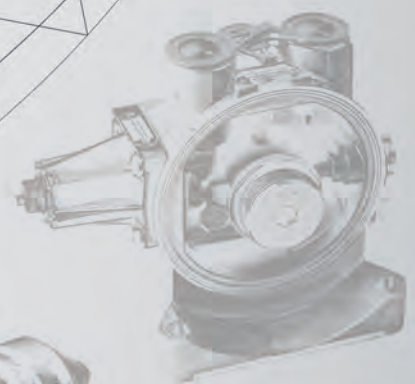
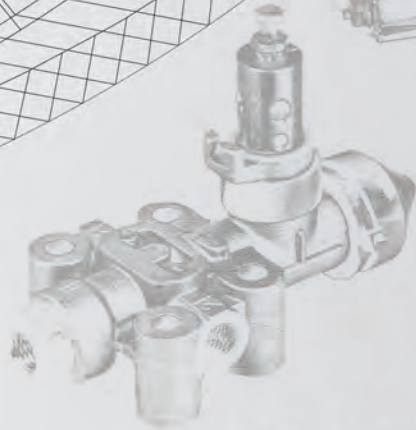
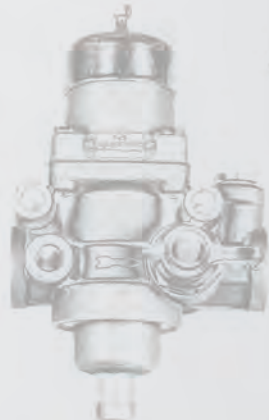
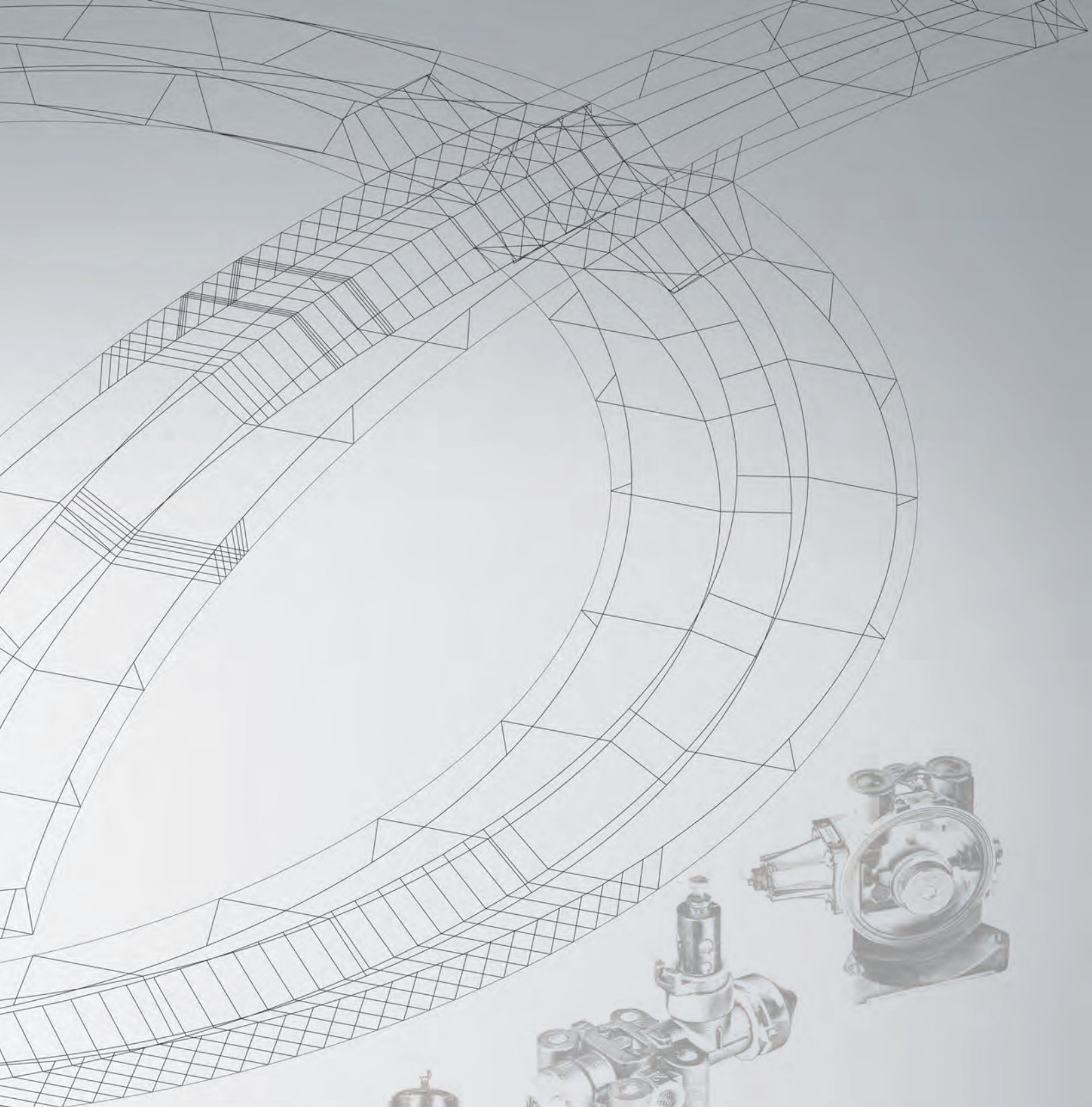

**UNLOADER VALVES
AIR DRYER VALVES
VALVES & OTHER**

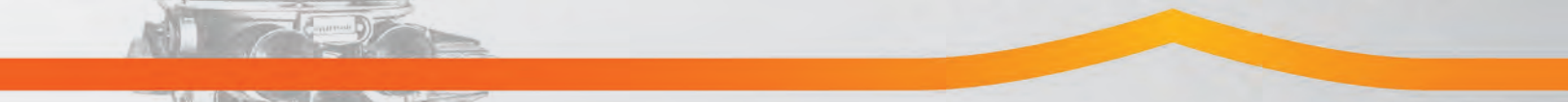

UNLOADER VALVES AND REPAIR KITS

REPAIR KITS

RK.03.002



Oem Ref. No:
975300002



Yumak No	Reference No	Description	Motor Type
03.01.001	9753001100	With Tyre Inflator - Şişiricili	8.1 bar Mercedes - Ikarus
03.01.002	9753001120	With Tyre Inflator - Şişiricili	7.8 bar Mercedes
03.01.003	9753000130	Without Tyre Inflator - Şişiricisiz	7.3 bar Volvo - Daf - Iveco
03.01.009	9753001110	With Tyre Inflator - Şişiricili	7.3 bar Mercedes - Steyr
03.01.013	9753000950	With Tyre Inflator - Şişiricili	15 bar Mercedes
03.01.014	9753005510	Without Tyre Inflator - Şişiricisiz	8.5 bar Renault - Van Hool
03.01.015	9753005500	Without Tyre Inflator - Şişiricisiz	9.3 bar Iveco - Man - Faun
03.01.016	9753005020	With Tyre Inflator - Şişiricili	8.0 bar Setra - Volvo - Iveco
03.01.017	9753001560	With Tyre Inflator - Şişiricili	8.5 bar Mercedes - Man
03.01.029	9753000140	Without Tyre Inflator - Şişiricisiz	8.1 bar Mercedes

UNLOADER VALVES AND REPAIR KITS

REPAIR KITS

RK.03.001

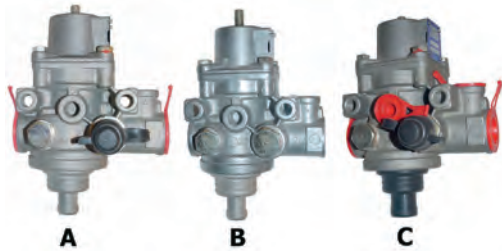

Oem Ref. No:
1487010165



Yumak No	Reference No	Description	Motor Type
03.02.001	0481039221	B Without Tyre Inflator - Şişiricisiz	8.1 bar Mercedes - Steyr
03.02.002	0481039209	C With Tyre Inflator - Şişiricili	8.1 bar Mercedes - Grau
03.02.003	0481039240	A With Tyre Inflator - Şişiricili	8.5 bar Mercedes
03.02.004	0481039210	A With Tyre Inflator - Şişiricili	8.0 bar Renault
03.02.007	0481039201	A With Tyre Inflator - Şişiricili	8.1 bar Mercedes
03.02.006	0481039213	C With Tyre Inflator - Şişiricili	10 bar Kassbohrer-Grau
03.02.009	0481039202	A With Tyre Inflator - Şişiricili	7.3 bar Mercedes-Renault
03.02.010	0481039218	A With Tyre Inflator - Şişiricili	7.8 bar Iveco
03.02.011	0481039222	B Without Tyre Inflator - Şişiricisiz	12 bar Mercedes
03.02.012	0481039234	C With Tyre Inflator - Şişiricili	8.1 bar Kassbohrer
03.02.013	0481039241	C With Tyre Inflator - Şişiricili	8.5 bar Mercedes

UNLOADER VALVES

UNLOADER VALVES AND REPAIR KITS

REPAIR KITS

RK.03.003

Oem Ref. No:
9753030012

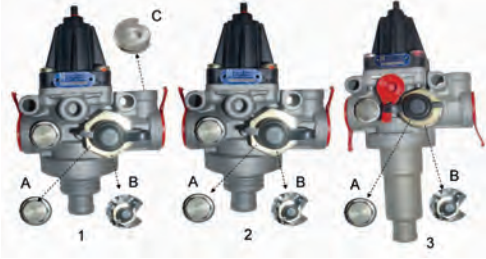

Yumak No	Reference No	Description		Motor Type		
03.01.005	9753034740	1	B	With Tyre Inflator - Şişiricili	10 bar	Daf - Nato - Mercedes
03.01.006	9753035040	1	B	With Tyre Inflator - Şişiricili	10 bar	Man - Mercedes
03.01.034	9753030850	1	A	Without Tyre Inflator - Şişiricisiz	9.5 bar	Mercedes
03.01.023	9753034720	1	B	With Tyre Inflator - Şişiricili	8.0 bar	Man - Mercedes
03.01.031	9753035410	1	B	With Tyre Inflator - Şişiricili	12 bar	Mercedes
03.01.020	9753030610	1	A	Without Tyre Inflator - Şişiricisiz	8.1 bar	Daf-Man-Iveco Mercedes-Nato
03.01.021	9753030720	1	B	With Tyre Inflator - Şişiricili	8.5 bar	Daf-Man-Iveco Mercedes-Scania
03.01.004	9753034730	2	B	With Tyre Inflator - Şişiricili	8.1 bar	Volvo-Mercedes Iveco-Renault
03.01.007	9753030810	2	A	Without Tyre Inflator - Şişiricisiz	9.5 bar	Marelli-Mercedes Man-Renault
03.01.024	9753034470	2	B	With Tyre Inflator - Şişiricili	7.3 bar	Marelli-Mercedes Man-Renault
03.01.025	9753034410	2	B	With Tyre Inflator - Şişiricili	7.8 bar	Iveco-Liebherr Nato-Magirus
03.01.028	9753034630	2	B	With Tyre Inflator - Şişiricili	8.5 bar	Renault
03.01.022	9753030820	2	A	Without Tyre Inflator - Şişiricisiz	9.8 bar	Daf
03.01.032	9753031200	2	A	Without Tyre Inflator - Şişiricisiz	11 bar	Iveco-Marelli
03.01.033	9753034690	2	B	With Tyre Inflator - Şişiricili	8.5 bar	Mercedes-Renault
03.01.008	9753034780	3	B	With Tyre Inflator - Şişiricili	8.1 bar	Daf-Man-Iveco Scania-Volvo
03.01.018	9753030840	3	A	Without Tyre Inflator - Şişiricisiz	9.5 bar	Man-Iveco-Scania Mercedes-Renault
03.01.026	9753034460	3	B	With Tyre Inflator - Şişiricili	7.8 bar	Liebherr-Nato
03.01.027	975.303.140.0	3	A	Without Tyre Inflator - Şişiricisiz	12.5 bar	Man
03.01.035	9753032200	3	A	Without Tyre Inflator - Şişiricisiz	16 bar	Iveco-Man

AIR DRYER VALVES AND REPAIR KITS

REPAIR KITS

RK.03.006



Oem Ref. No:

4324100022
93161813



Yumak No	Reference No	Desc.	Bar
03.03.005.F	4324100000	24V	8.1
03.03.048.F	4324100030	12V	8.1
03.03.049.F	4324100040	24V	11.0
03.03.033.F	4324100050	-	10.0
03.03.013.F	4324100070	24V	8.5
03.03.008.F	4324100080	24V	11.8
03.03.050.F	4324100100	24V	9.3
03.03.023.F	4324100110	24V	12.2
03.03.051.F	4324100120	24V	9.3
03.03.030.F	4324100200	24V	9.5
03.03.035.F	4324100210	-	9.5
03.03.027.F	4324100220	24V	9.5
03.03.015.F	4324100230	-	11.0
03.03.052.F	4324100240	24V	9.5
03.03.053.F	4324100250	24V	9.5
03.03.014.F	4324100260	24V	9.8
03.03.031.F	4324100270	24V	10.0
03.03.054.F	4324100280	24V	8.1
03.03.055.F	4324100300	24V	16.5
03.03.016.F	4324100310	-	7.8
03.03.056.F	4324100330	-	12.5
03.03.057.F	4324100340	24V	12.5
03.03.058.F	4324100350	24V	11.0
03.03.032.F	4324100360	24V	7.3
03.03.059.F	4324100370	-	7.3
03.03.060.F	4324100380	-	12.5
03.03.017.F	4324100410	24V	8.5
03.03.028.F	4324100420	24V	8.5
03.03.009.F	4324100430	24V	9.5
03.03.061.F	4324100440	24V	16.5

Yumak No	Reference No	Desc.	Bar
03.03.062.F	4324100490	24V	9.0
03.03.063.F	4324100500	24V	8.1
03.03.064.F	4324100640	-	8.2
03.03.065.F	4324100660	-	8.5
03.03.018.F	4324100670	24V	8.5
03.03.066.F	4324100680	-	10.0
03.03.029.F	4324100690	24V	10.0
03.03.067.F	4324100730	-	11.0
03.03.068.F	4324100740	-	12.5
03.03.069.F	4324100750	24V	11.0
03.03.070.F	4324100760	24V	12.5
03.03.071.F	4324100780	-	8.5
03.03.025.F	4324101020	24V	8.1
03.03.040.F	4324101040	24V	8.1
03.03.034.F	4324101100	24V	12.5
03.03.011.F	4324101110	-	12.5
03.03.036.F	4324101120	24V	12.5
03.03.012.F	4324101130	-	12.5
03.03.037.F	4324101140	24V	8.5
03.03.072.F	4324101150	-	8.5
03.03.073.F	4324101160	24V	10.5
03.03.007.F	4324101170	-	10.5
03.03.022.F	4324101180	24V	8.8
03.03.074.F	4324102000	24V	8.1
03.03.079.F	4324102010	-	8.1
03.03.075.F	4324102020	-	8.1
03.03.076.F	4324102030	24V	8.5
03.03.077.F	4324102500	24V	10.0
03.03.078.F	4324102510	-	10.0
03.03.046.F	4324101040	24V	8.1
03.03.087.F	4324100850 4324101910	24V	12

AIR DRYER VALVES

AIR DRYER VALVES AND REPAIR KITS

REPAIR KITS

RK.03.006



Oem Ref. No:
4324100022
93161813



Yumak No	Reference No	Desc.	Bar
03.03.005	4324100000	24V	8.1
03.03.048	4324100030	12V	8.1
03.03.049	4324100040	24V	11.0
03.03.033	4324100050	-	10.0
03.03.013	4324100070	24V	8.5
03.03.008	4324100080	24V	11.8
03.03.050	4324100100	24V	9.3
03.03.023	4324100110	24V	12.2
03.03.051	4324100120	24V	9.3
03.03.030	4324100200	24V	9.5
03.03.035	4324100210	-	9.5
03.03.027	4324100220	24V	9.5
03.03.015	4324100230	-	11.0
03.03.052	4324100240	24V	9.5
03.03.053	4324100250	24V	9.5
03.03.014	4324100260	24V	9.8
03.03.031	4324100270	24V	10.0
03.03.054	4324100280	24V	8.1
03.03.055	4324100300	24V	16.5
03.03.016	4324100310	-	7.8
03.03.056	4324100330	-	12.5
03.03.057	4324100340	24V	12.5
03.03.058	4324100350	24V	11.0
03.03.032	4324100360	24V	7.3
03.03.059	4324100370	-	7.3
03.03.060	4324100380	-	12.5
03.03.017	4324100410	24V	8.5
03.03.028	4324100420	24V	8.5
03.03.009	4324100430	24V	9.5
03.03.061	4324100440	24V	16.5

Yumak No	Reference No	Desc.	Bar
03.03.062	4324100490	24V	9.0
03.03.063	4324100500	24V	8.1
03.03.064	4324100640	-	8.2
03.03.065	4324100660	-	8.5
03.03.018	4324100670	24V	8.5
03.03.066	4324100680	-	10.0
03.03.029	4324100690	24V	10.0
03.03.067	4324100730	-	11.0
03.03.068	4324100740	-	12.5
03.03.069	4324100750	24V	11.0
03.03.070	4324100760	24V	12.5
03.03.071	4324100780	-	8.5
03.03.025	4324101020	24V	8.1
03.03.040	4324101040	24V	8.1
03.03.034	4324101100	24V	12.5
03.03.011	4324101110	-	12.5
03.03.036	4324101120	24V	12.5
03.03.012	4324101130	-	12.5
03.03.037	4324101140	24V	8.5
03.03.072	4324101150	-	8.5
03.03.073	4324101160	24V	10.5
03.03.007	4324101170	-	10.5
03.03.022	4324101180	24V	8.8
03.03.074	4324102000	24V	8.1
03.03.036	4324102010	-	8.1
03.03.075	4324102020	-	8.1
03.03.076	4324102030	24V	8.5
03.03.077	4324102500	24V	10.0
03.03.078	4324102510	-	10.0
03.03.046	4324101040	24V	13
03.03.087	4324100850 4324101910	24V	13

AIR DRYER VALVES AND REPAIR KITS

REPAIR KITS

RK.03.005

Oem Ref. No:

432410002
0014308360



Yumak No	Reference No	Description	Bar	Motor Type
03.03.004.F	4324210000 0004317215 0004317915 110273401	24V - 100W	13 bar	Daimler - Daf Chrysler - Neoplan
03.03.006.F	4324210020 0004318015	WITHOUT HEATING	13 bar	Daimler - Daf Chrysler - Neoplan
03.03.020.F	4324210070 0014310815 0014312115 1517977	24V - 100W	13 bar	Daimler - Daf Chrysler - Neoplan
03.03.021.F	4324210080 0004310415 1517978 0014312215	WITHOUT HEATING	13 bar	Daimler - Daf Chrysler - Neoplan
03.03.035.F	4324200010 4324200000	WITHOUT HEATING	13 bar	Daimler - Daf Chrysler - Neoplan
03.03.043.F	4324200020	WITHOUT HEATING	13 bar	

AIR DRYER VALVES

AIR DRYER VALVES AND REPAIR KITS

REPAIR KITS

RK.03.005

Oem Ref. No:

4324100002
0014308360



Yumak No	Reference No	Description	Bar	Motor Type
03.03.004	4324210000 0004317215 0004317915 110273401	24V - 100W	13 bar	Daimler - Daf Chrysler - Neoplan
03.03.006	4324210020 0004318015	WITHOUT HEATING	13 bar	Daimler - Daf Chrysler - Neoplan
03.03.020	4324210070 0014310815 0014312115 1517977	24V - 100W	13 bar	Daimler - Daf Chrysler - Neoplan
03.03.021	4324210080 0004310415 1517978 0014312215	WITHOUT HEATING	13 bar	Daimler - Daf Chrysler - Neoplan
03.03.035	4324200010 4324200000	WITHOUT HEATING	13 bar	Daimler - Daf Chrysler - Neoplan
03.03.043	4324200020	WITHOUT HEATING	13 bar	

AIR DRYER VALVES AND REPAIR KITS

REPAIR KITS

RK.03.008



Oem Ref. No:
1136248 / 008



Yumak No	Reference No	Desc.	Bar
03.04.001.F	LA8200	24 V	8.5
03.04.002.F	LA8201	24 V	10
03.04.024.F	LA8202	24 V	12
03.04.025.F	LA8203	-	8.5
03.04.026.F	LA8204	-	10
03.04.027.F	LA8205 / LA6268	-	12
03.04.003.F	LA8206 / LA6248	24 V	9.8
03.04.028.F	LA8207	-	9.5
03.04.029.F	LA8208	24 V	8.5
03.04.030.F	LA8209	-	10
03.04.031.F	LA8210	24 V	10
03.04.032.F	LA8211	-	12.5
03.04.033.F	LA8212	24 V	12.5
03.04.034.F	LA8219	-	11
03.04.004.F	LA8220	24 V	11
03.04.005.F	LA8221	-	12.5
03.04.006.F	LA8222	24 V	12.5
03.04.007.F	LA8223	24 V	8.4
03.04.035.F	LA8224	24 V	8.4
03.04.008.F	LA8225 / LA6252	24 V	8.1
03.04.036.F	LA8226	24 V	8.4
03.04.037.F	LA8227	24 V	10
03.04.038.F	LA8228 / LA6200	-	8.1
03.04.009.F	LA8229 / LA6205	-	9.5
03.04.039.F	LA8230	24 V	10
03.04.040.F	LA8231	-	7.8
03.04.041.F	LA8232	-	12.5
03.04.010.F	LA8233 / LA6209	24 V	12.5
03.04.011.F	LA8234	24 V	8.1
03.04.042.F	LA8235	-	10
03.04.043.F	LA8236	-	8.1
03.04.044.F	LA8237	24 V	8.1
03.04.045.F	LA8238	12 V	8.4
03.04.046.F	LA8239	YOK	7.35
03.04.047.F	LA8240	24 V	8.4

Yumak No	Reference No	Desc.	Bar
03.04.021.F	LA8241	24 V	12.5
03.04.013.F	LA8242 / LA6215	24 V	11
03.04.014.F	LA8243	24 V	9.5
03.04.015.F	LA8244	24 V	7.8
03.04.016.F	LA8245 / LA6217	24 V	8.5
03.04.048.F	LA8247	24 V	9.5
03.04.049.F	LA8248	-	7.35
03.04.050.F	LA8249	24 V	8.5
03.04.051.F	LA8250	24 V	7.35
03.04.052.F	LA8251	-	7.35
03.04.053.F	LA8252	-	8.3
03.04.054.F	LA8253	-	8.1
03.04.055.F	LA8254 / LA6222	-	12.5
03.04.056.F	LA8255	24 V	12.5
03.04.057.F	LA8256	24 V	10
03.04.058.F	LA8257	24 V	8.1
03.04.059.F	LA8258	-	10
03.04.060.F	LA8259	24 V	8.3
03.04.061.F	LA8261	25 V	12.5
03.04.062.F	LA8263	-	9.8
03.04.063.F	LA8267	12 V	8.5
03.04.064.F	LA8268	12 V	10
03.04.065.F	LA8269	24 V	8.1
03.04.066.F	LA8270	24 V	10
03.04.017.F	LA8271	24 V	8.5
03.04.067.F	LA8273	24 V	12.5
03.04.068.F	LA8275	-	8.1
03.04.069.F	LA8280	12 V	8.5
03.04.070.F	LA8281	12 V	10
03.04.071.F	LA8282	12 V	12
03.04.072.F	LA8283	24 V	7.9
03.04.019.F	LA8284	24 V	9.8
03.04.073.F	LA8286	24 V	12
03.04.074.F	LA8288	24 V	12.5
03.04.020.F	LA8700	-	13

AIR DRYER VALVES

AIR DRYER VALVES AND REPAIR KITS

REPAIR KITS

RK.03.008



Oem Ref. No:
1136248 / 008



Yumak No	Reference No	Desc.	Bar
03.04.001	LA8200	24 V	8.5
03.04.002	LA8201	24 V	10
03.04.024	LA8202	24 V	12
03.04.025	LA8203	-	8.5
03.04.026	LA8204	-	10
03.04.027	LA8205 / LA6268	-	12
03.04.003	LA8206 / LA6248	24 V	9.8
03.04.028	LA8207	-	9.5
03.04.029	LA8208	24 V	8.5
03.04.030	LA8209	-	10
03.04.031	LA8210	24 V	10
03.04.032	LA8211	-	12.5
03.04.033	LA8212	24 V	12.5
03.04.034	LA8219	-	11
03.04.004	LA8220	24 V	11
03.04.005	LA8221	-	12.5
03.04.006	LA8222	24 V	12.5
03.04.007	LA8223	24 V	8.4
03.04.035	LA8224	24 V	8.4
03.04.008	LA8225 / LA6252	24 V	8.1
03.04.036	LA8226	24 V	8.4
03.04.037	LA8227	24 V	10
03.04.038	LA8228 / LA6200	-	8.1
03.04.009	LA8229 / LA6205	-	9.5
03.04.039	LA8230	24 V	10
03.04.040	LA8231	-	7.8
03.04.041	LA8232	-	12.5
03.04.010	LA8233 / LA6209	24 V	12.5
03.04.011	LA8234	24 V	8.1
03.04.042	LA8235	-	10
03.04.043	LA8236	-	8.1
03.04.044	LA8237	24 V	8.1
03.04.045	LA8238	12 V	8.4
03.04.046	LA8239	YOK	7.35
03.04.047	LA8240	24 V	8.4

Yumak No	Reference No	Desc.	Bar
03.04.021	LA8241	24 V	12.5
03.04.013	LA8242 / LA6215	24 V	11
03.04.014	LA8243	24 V	9.5
03.04.015	LA8244	24 V	7.8
03.04.016	LA8245 / LA6217	24 V	8.5
03.04.048	LA8247	24 V	9.5
03.04.049	LA8248	-	7.35
03.04.050	LA8249	24 V	8.5
03.04.051	LA8250	24 V	7.35
03.04.052	LA8251	-	7.35
03.04.053	LA8252	-	8.3
03.04.054	LA8253	-	8.1
03.04.055	LA8254 / LA6222	-	12.5
03.04.056	LA8255	24 V	12.5
03.04.057	LA8256	24 V	10
03.04.058	LA8257	24 V	8.1
03.04.059	LA8258	-	10
03.04.060	LA8259	24 V	8.3
03.04.061	LA8261	25 V	12.5
03.04.062	LA8263	-	9.8
03.04.063	LA8267	12 V	8.5
03.04.064	LA8268	12 V	10
03.04.065	LA8269	24 V	8.1
03.04.066	LA8270	24 V	10
03.04.017	LA8271	24 V	8.5
03.04.067	LA8273	24 V	12.5
03.04.068	LA8275	-	8.1
03.04.069	LA8280	12 V	8.5
03.04.070	LA8281	12 V	10
03.04.071	LA8282	12 V	12
03.04.072	LA8283	24 V	7.9
03.04.019	LA8284	24 V	9.8
03.04.073	LA8286	24 V	12
03.04.074	LA8288	24 V	12.5
03.04.020	LA8700	-	13

03.06.002.F AIR DRYER VALVE

Oem Ref. No:	Oil:	Vehicle:
9324000010		MERCEDES
9324000240		ISITICISIZ 12 BAR
0004301215		
0004302915		
0004303015 /0014319215		
0004309815 /9324000230		



03.06.003.F AIR DRYER VALVE

Oem Ref. No:	Oil:	Vehicle:
9324000060		MERCEDES
		ISITICILI 12 BAR



03.06.004.F AIR DRYER VALVE

Oem Ref. No:	Oil:	Vehicle:
9325000060		MERCEDES
0014317815		ISITICISIZ 12 BAR
9325001100		
0014318115		



03.06.005.F AIR DRYER VALVE

Oem Ref. No:	Oil:	Vehicle:
9324000020		MERCEDES
0004301315		ISITICILI 12 BAR



03.06.006.F AIR DRYER VALVE

Oem Ref. No:	Oil:	Vehicle:
9324000050		MERCEDES
		ISITICISIZ 12 BAR



AIR DRYER VALVES

03.06.007.F

AIR DRYER VALVE

Oem Ref. No:

9324000140
9324000160
0004306315
0024315715

Oil:

Vehicle:

MERCEDES
ISITICILI BAYONETLİ



03.06.008.F

AIR DRYER VALVE

Oem Ref. No:

4324150160

Oil:

Vehicle:

MERCEDES



03.06.009.F

AIR DRYER VALVE

Oem Ref. No:

4324150030

Oil:

Vehicle:



03.06.010.F

AIR DRYER VALVE

Oem Ref. No:

LA8220

Oil:

Vehicle:



03.06.011.F

AIR DRYER VALVE

Oem Ref. No:

9325001020
5801414923

Oil:

Vehicle:

IVECO STALIS



03.06.012.F

AIR DRYER VALVE

Oem Ref. No:

9325000070
9325000140
0014318215
0024310715

Oil:

Vehicle:

MERCEDES
ISITICILI 12 BAR



03.06.013.F

AIR DRYER VALVE

Oem Ref. No:

9324000030

Oil:

Vehicle:

ISITICISIZ 10 BAR



03.04.075.F

AIR DRYER VALVE

Oem Ref. No:

LA8553

Oil:

Vehicle:



03.04.076.F

AIR DRYER VALVE

Oem Ref. No:

LA8132

Oil:

Vehicle:



03.04.077.F

AIR DRYER VALVE

Oem Ref. No:

LA8125
Z

Oil:

Vehicle:



03.04.078.F

AIR DRYER VALVE

Oem Ref. No:

LA9002

Oil:

Vehicle:



AIR DRYER VALVES

03.05.001.F

AIR DRYER VALVE

Oem Ref. No:
ZB4400

Oil:

Vehicle:



03.05.002.F

AIR DRYER VALVE

Oem Ref. No:
ZB4593

Oil:

Vehicle:
LA8132+AE4528



03.05.003.F

AIR DRYER VALVE

Oem Ref. No:
ZB4587

Oil:

Vehicle:



03.05.004.F

AIR DRYER VALVE

Oem Ref. No:
ZB4803

Oil:

Vehicle:



05.02.011

CIRCUIT PROTECTION VALVE

Oem Ref. No:
9347050050
0034315706

Oil:

Vehicle:



05.02.016

CIRCUIT PROTECTION VALVE

Oem Ref. No:
9347050020

Oil:

Vehicle:



05.02.017
CIRCUT PROTECTION VALVE
Oem Ref. No:
AE4502

Oil:
Vehicle:

05.02.022
CIRCUT PROTECTION VALVE
Oem Ref. No:
AE4528
II37464N50

Oil:
Vehicle:

03.04.047.F
HYDRAIR CLUTCH SERVO
Oem Ref. No:
LA8240

Oil:
Vehicle:
MAN / MERCEDES
VOLVO / SCANIA / DAF
RENAULT / IVECO / FORD

11.01.001
LOAD SENSING RELAY EMERGENCY VALVE
Oem Ref. No:
4757155000
0203321300
1506232
352132

Oil:
Vehicle:
DAF CF

11.01.002
LOAD SENSING RELAY EMERGENCY VALVE
Oem Ref. No:
4757120000
1325324
BBU8129

Oil:
Vehicle:

RK.11.002
REPAIR KITS
Oem Ref. No:
4757120002

AIR DRYER VALVES

11.02.001

LOAD SENSING RELAY EMERGENCY VALVE

Oem Ref. No:
4756040100
1271399
81521616174

Oil:

Vehicle:



RK.11.005

REPAIR KITS

Oem Ref. No:
4756040022



11.01.005

LOAD SENSING RELAY EMERGENCY VALVE

Oem Ref. No:
4757101360
0034312712

Oil:

Vehicle:
AXOR 3028



RK.11.006

REPAIR KITS

Oem Ref. No:
4757100012



05.05.001

AIR DRYER VALVE

Oem Ref. No:
202002001

Oil:

Vehicle:



05.03.002

LOAD SENSING RELAY EMERGENCY VALVE

Oem Ref. No:
4341001310

Oil:

Vehicle:



05.02.018

CIRCUT PROTECTION VALVE

Oem Ref. No:
AE4516

Oil:

Vehicle:



05.02.019

CIRCUT PROTECTION VALVE

Oem Ref. No:
AE4612

Oil:

Vehicle:
TEMSA



06.04.009

LEVELLING VALVE

Oem Ref. No:
4640070010
81436106129

Oil:

Vehicle:
MAN
DAF
IVECO
RENAULT



06.04.019

LEVELLING VALVE

Oem Ref. No:
464.007.010.0

Oil:

Vehicle:
SCANIA



12.01.025

RELAY VALVES

Oem Ref. No:
973.011.203.0

Oil:

Vehicle:



AIR DRYER VALVES

12.01.027

RELAY VALVES

Oem Ref. No:
9730112060
5010260705

Oil:

Vehicle:



21.01.003

QUICK RELEASE VALVE

Oem Ref. No:
9735000340

Oil:

Vehicle:



20.05.003

Oem Ref. No:
ZFNO:1304334079
81326380039

Oil:

Vehicle:
MAN



03.08.002

HYDRAIR CLUTCH SERVO

Oem Ref. No:

Oil:

Vehicle:
MAN / MERCEDES
VOLVO / SCANIA / DAF
RENAULT / IVECO / FORD



13.06.001

SELECT CYLINDER

Oem Ref. No:
81326556182
629219AM

Oil:

Vehicle:
MAN TGA



13.06.002

SHIFT CYLINDER

Oem Ref. No:
629218AM
81326556181

Oil:

Vehicle:
MAN TGA



LEVELLING VALVES AND REPAIR KITS

REPAIR KITS

RK.06.001

Oem Ref. No:
1507010007

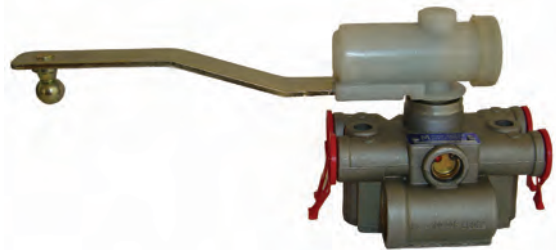
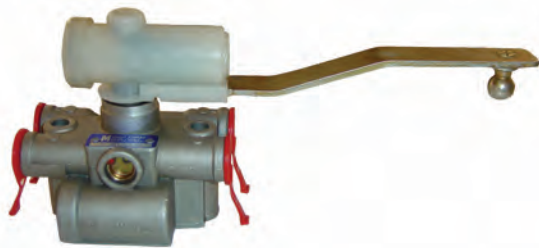

Yumak No	Reference No	Bar
06.01.001	0500005001 0003282030	12
06.01.005	0500005101 0003283430	12

Yumak No	Reference No	Bar
06.01.002	0500005002 0003282130	12
06.01.006	0500005102 0003283730	12



Yumak No	Reference No	Bar
06.01.003	0500005006	10
06.01.011	0500005104 0003283930	12

Yumak No	Reference No	Bar
06.01.004	0500005007	10
06.01.012	0500005105	12

LEVELLING VALVES AND REPAIR KITS

REPAIR KITS

RK.06.004

Oem Ref. No:



Yumak No	Reference No	Desc.	Vehicle
06.02.001	SV1294		
06.02.003	SV1310		
06.02.008	SV1260		
06.02.010	SV1278		
06.02.013	SV1412		
06.02.035	SV1271		
06.02.039	SV1339		
06.02.040	SV1340		
06.02.046	SV1433		
06.02.058	SV1279		
06.02.072	SV1345		
06.02.101	SV1445		

Yumak No	Reference No	Desc.	Vehicle
06.02.001.K	SV1294		
06.02.003.K	SV1310		
06.02.008.K	SV1260		
06.02.010.K	SV1278		
06.02.013.K	SV1412		
06.02.035.K	SV1271		
06.02.039.K	SV1339		
06.02.040.K	SV1340		
06.02.046.K	SV1433		
06.02.058.K	SV1279		
06.02.072.K	SV1345		
06.02.101.K	SV1445		



Yumak No	Reference No	Desc.	Vehicle
06.02.002	SV1307		
06.02.055	SV1455		
06.02.067	SV1483		
06.02.103	SV1372		
06.02.104	SV1367		
06.02.105	SV1486		
06.02.106	SV1487		
06.02.109	SV1395-II19425-612035021		

Yumak No	Reference No	Desc.	Vehicle
06.02.002.K	SV1307		
06.02.055.K	SV1455		
06.02.067.K	SV1483		
06.02.103.K	SV1372		
06.02.104.K	SV1367		
06.02.105.K	SV1486		
06.02.106.K	SV1487		
06.02.109.K	SV1395-II19425-612035021		

LEVELLING VALVES AND REPAIR KITS

REPAIR KITS

RK.06.004

Oem Ref. No:



Yumak No	Reference No	Desc.	Vehicle
06.02.014	SV1468		
06.02.054	SV1288		
06.02.102	SV1494		

Yumak No	Reference No	Desc.	Vehicle
06.02.014.K	SV1468		
06.02.054.K	SV1288		
06.02.102.K	SV1494		



Yumak No	Reference No	Desc.	Vehicle
06.02.004	SV1295 / I85698		
06.02.016	SV1323 / I132764	TEMSA	
06.02.017	SV1399		
06.02.018	SV1318	TEMSA	SAFİR
06.02.019	SV1321		
06.02.020	SV1328 / I132765		
06.02.032	SV1351		
06.02.066	SV1434		
06.02.076	SV1352		
06.02.107	SV1432		
06.02.108	SV1431		

Yumak No	Reference No	Desc.	Vehicle
06.02.004.K	SV1295 / I85698		
06.02.016.K	SV1323 / I132764	TEMSA	
06.02.017.K	SV1399		
06.02.018.K	SV1318	TEMSA	SAFİR
06.02.019.K	SV1321		
06.02.020.K	SV1328 / I132765		
06.02.032.K	SV1351		
06.02.066.K	SV1434		
06.02.076.K	SV1352		
06.02.107.K	SV1432		
06.02.108.K	SV1431		

06.054

120 MM



06.055

160 MM



06.056

210 MM



LEVELLING VALVES AND REPAIR KITS



Yumak No	Reference No	Desc.	Vehicle
06.02.007	SV1280		
06.02.022	SV1419		
06.02.023	SV1329		
06.02.024	SV1330		
06.02.025	SV1370		
06.02.026	SV1377		
06.02.027	SV1378		
06.02.034	SV1325		
06.02.077	SV1442		
06.02.078	SV1425 / II16189 / 8189439		VOLVO
06.02.086	SV1403		
06.02.087	SV1404		
06.02.088	SV1416		
06.02.089	SV1417		
06.02.090	SV1421		
06.02.091	SV1422		
06.02.092	SV1427		
06.02.093	SV1428		
06.02.094	SV1429		
06.02.095	SV1430		
06.02.096	SV1435		
06.02.097	SV1436		
06.02.098	SV1437		
06.02.099	SV1441		
06.02.100	SV1443		

Yumak No	Reference No	Desc.	Vehicle
06.02.007.K	SV1280		
06.02.022.K	SV1419		
06.02.023.K	SV1329		
06.02.024.K	SV1330		
06.02.025.K	SV1370		
06.02.026.K	SV1377		
06.02.027.K	SV1378		
06.02.034.K	SV1325		
06.02.077.K	SV1442		
06.02.078.K	SV1425 / II16189 / 8189439		VOLVO
06.02.086.K	SV1403		
06.02.087.K	SV1404		
06.02.088.K	SV1416		
06.02.089.K	SV1417		
06.02.090.K	SV1421		
06.02.091.K	SV1422		
06.02.092.K	SV1427		
06.02.093.K	SV1428		
06.02.094.K	SV1429		
06.02.095.K	SV1430		
06.02.096.K	SV1435		
06.02.097.K	SV1436		
06.02.098.K	SV1437		
06.02.099.K	SV1441		
06.02.100.K	SV1443		



Yumak No	Reference No	Desc.	Vehicle
06.02.015	SV1411		

Yumak No	Reference No	Desc.	Vehicle
06.02.015.K	SV1411		

LEVELLING VALVES AND REPAIR KITS



Yumak No	Reference No	Desc.	Kullanıldığı Araç
06.02.005	SV1281		422 ÇEKİCİ
06.02.028	SV1284		
06.02.030	SV1301		
06.02.031	SV1303 / II32763		SCANIA / DAF
06.02.033	SV1363		
06.02.052	SV1409		
06.02.079	SV1426		



Yumak No	Reference No	Desc.	Kullanıldığı Araç
06.02.028.K	SV1281		422 ÇEKİCİ
06.02.028.K	SV1284		
06.02.030.K	SV1301		
06.02.031.K	SV1303 / II32763		SCANIA / DAF
06.02.033.K	SV1363		
06.02.052.K	SV1409		
06.02.079.K	SV1426		



Yumak No	Reference No	Desc.	Vehicle
06.02.056	SV1410		
06.02.081	SV1418		
06.02.082	SV1440		
06.02.083	SV1447		
06.02.084	SV1466		



Yumak No	Reference No	Desc.	Vehicle
06.02.056.K	SV1410		
06.02.081.K	SV1418		
06.02.082.K	SV1440		
06.02.083.K	SV1447		
06.02.084.K	SV1466		



Yumak No	Reference No	Desc.	Vehicle
06.02.021	SV1381		
06.02.029	SV1287		
06.02.057	SV1298		
06.02.065	SV1299		
06.02.080	SV1380		



Yumak No	Reference No	Desc.	Vehicle
06.02.021.K	SV1381		
06.02.029.K	SV1287		
06.02.057.K	SV1298		
06.02.065.K	SV1299		
06.02.080.K	SV1380		

LEVELLING VALVES AND REPAIR KITS



Yumak No	Reference No	Desc.	Vehicle
06.04.002	4640060020	13 Bar	
06.04.003	4640060040	13 Bar	
06.04.008	4640060010	13 Bar	
06.04.011	4640060050	13 Bar	
06.04.012	4640060060	13 Bar	
06.04.013	4640060070	13 Bar	
06.04.014	4640060090	13 Bar	
06.04.015	4640060120	13 Bar	
06.04.020	4640060110	13 Bar	Daf-Iveco



Yumak No	Reference No	Desc.	Vehicle
06.04.002.K	4640060020	13 Bar	
06.04.002.K	4640060040	13 Bar	
06.04.008.K	4640060010	13 Bar	
06.04.011.K	4640060050	13 Bar	
06.04.012.K	4640060060	13 Bar	
06.04.013.K	4640060070	13 Bar	
06.04.014.K	4640060090	13 Bar	
06.04.015.K	4640060120	13 Bar	
06.04.020.K	4640060110	13 Bar	Daf-Iveco



Yumak No	Reference No	Desc.	Vehicle
06.04.007	4640061000 0243113500	15 Bar	MAN BPW



Yumak No	Reference No	Desc.	Vehicle
06.04.007.K	4640061000 0243113500	15 Bar	MAN BPW



Yumak No	Reference No	Desc.	Vehicle
06.04.004	4640060000	13 Bar	Volvo



Yumak No	Reference No	Desc.	Vehicle
06.04.004.K	4640060000	13 Bar	Volvo

- 06.04.002
- 06.04.003
- 06.04.008
- 06.04.011
- 06.04.012
- 06.04.013
- 06.04.014
- 06.04.015
- 06.04.007
- 06.04.004

Yumak No	Reference No
RK.06.003	4640060002



06.053

06.052

06.051

06.050

06.04.016

LEVELLING VALVE

Oem Ref. No:

4640070020
5021170190
1505082
8141934
1518094
08188642
20531967
3198233

Desc:

M10

Vehicle:

VOLVO
RENAULT
DAF
IVECO



06.04.017

LEVELLING VALVE

Oem Ref. No:

4640070040

Desc:

M10

Vehicle:

DAIMLER
MAN



06.04.018

LEVELLING VALVE

Oem Ref. No:

4640070110
1518095
0003284530
0003284530

Desc:

M10

Vehicle:

MERCEDES
DAIMLER
AXOR
ACTROS
EVOBUS
DAF



35.01.001

BRAKE ACTUATOR

Oem Ref. No:

BZ 6621

Desc:

M10

Vehicle:

Ø125



35.01.002

BRAKE ACTUATOR

Oem Ref. No:

BZ 6517

Desc:

M10

Vehicle:

Ø115



04.03.002

HYDRO BRAKE BOOSTER

Oem Ref. No:

8972243790
8972547710

Desc:

M10

Vehicle:

ISUZU



CIRCUIT PROTECTION VALVES AND REPAIR KITS

REPAIR KITS

RK.05.001



Oem Ref. No:
9347020042
0025865942



Yumak No	Reference No	Description	Motor Type
05.01.001	9347023000 / 0014313006	MAX 20 Bar	Mercedes 345 BUS
05.01.002	9347023810	MAX 20 Bar	Scania
05.01.005	9347020420	MAX 10 Bar	Volvo
05.01.006	9347023020	MAX 20 Bar	Iveco
05.01.008	9347021100	MAX 20 Bar	Renault
05.01.010	9347020000	MAX 10 Bar	Daf
05.01.011	9347020020	MAX 20 Bar	Daf
05.01.012	9347020050	MAX 10 Bar	Iveco
05.01.013	9347020400	MAX 10 Bar	Volvo
05.01.014	9347020410	MAX 10 Bar	Man
05.01.015	9347020450	MAX 10 Bar	Volvo
05.01.016	9347020470	MAX 10 Bar	Volvo
05.01.017	9347020820	MAX 20 Bar	Renault
05.01.018	9347021000	MAX 10 Bar	Volvo
05.01.019	9347023200	MAX 20 Bar	Mercedes
05.01.020	9347023220	MAX 20 Bar	Man
05.01.021	9347011010	MAX 20 Bar	Daf

CIRCUIT PROTECTION VALVES AND REPAIR KITS

REPAIR KITS

RK.05.002



Oem Ref. No:
9347020052



Yumak No	Reference No	Description	Motor Type
05.01.003	9347022210	MAX 20 Bar	Mercedes
05.01.004	9347022100	MAX 10 Bar	Mercedes
05.01.022	9347022200-0014317806	MAX 20 Bar	Mercedes
05.01.023	9347022230	MAX 20 Bar	Man
05.01.024	9347022400-0024209224-81521516039	MAX 10 Bar	Man-Mercedes

05.01.027

CIRCUIT PROTECTION VALVE

Oem Ref. No:
9347022500

Desc:

Vehicle:



05.01.031

CIRCUIT PROTECTION VALVE

Oem Ref. No:
9347140100
81521516073
81521516082

Desc:

Vehicle:
MAN SL 313 SOLO GNG



05.01.032

CIRCUIT PROTECTION VALVE

Oem Ref. No:
9347141520

Desc:

Vehicle:



05.02.002

CIRCUIT PROTECTION VALVE

Oem Ref. No:
AE 4158
I70615
0024311306

Desc:

Vehicle:
MERCEDES



05.02.004

CIRCUIT PROTECTION VALVE

Oem Ref. No:
AE 4162
I73329

Desc:

Vehicle:



05.02.009

CIRCUIT PROTECTION VALVE

Oem Ref. No:
AE 4609
I137460
81521516095

Desc:

Vehicle:
BMC
MAN TGA 33.360



05.02.010

CIRCUIT PROTECTION VALVE

Oem Ref. No:	Desc:	Vehicle:
AE4616	M16*1.5	IRISBUS



05.02.007

CIRCUIT PROTECTION VALVE

Oem Ref. No:	Desc:	Vehicle:
AE4604 I136012000		VOLVO FH12 / FM10-12 CITYBUS



05.02.012

CIRCUIT PROTECTION VALVE

Oem Ref. No:	Desc:	Vehicle:
AE4610 I137462		VOLVO DAF LEYLAND



05.02.013

CIRCUIT PROTECTION VALVE

Oem Ref. No:	Desc:	Vehicle:
AE4613 I138802F		MAN TGA IVECO



05.02.014

CIRCUIT PROTECTION VALVE

Oem Ref. No:	Desc:	Vehicle:
AE4615		MERCEDES AXOR / ACTROS / ATEGO



05.02.015

CIRCUIT PROTECTION VALVE

Oem Ref. No:	Desc:	Vehicle:
AE4620		MAN L2000 - M2000



RELAY VALVES AND REPAIR KITS

REPAIR KITS

RK.12.001



Oem Ref. No:
9730010002



Yumak No	Reference No	Description	Motor Type
12.01.001	9730010200	MAX 10 Bar	Mercedes - Volvo - Bmc
12.01.002	9730010100	MAX 8 Bar	Man - Iveco - Setra
12.01.013	9730010160	MAX 8 Bar	Mercedes
12.01.014	9730012100	MAX 10 Bar	Daf
12.01.016	9730010140	MAX 8 Bar	Iveco

RELAY VALVES AND REPAIR KITS

REPAIR KITS

RK.12.005



Oem Ref. No:
9730010062



Yumak No	Reference No	Description	Motor Type
12.01.005	9730012210	MAX 10 Bar	Daf - Man - Neoplan

RELAY VALVES AND REPAIR KITS

REPAIR KITS

RK.12.006



Oem Ref. No:
9730110022



Yumak No	Reference No	Description	Motor Type
12.01.011	9730110000	MAX 10 Bar	Iveco - Nato - Faun
12.01.006	9730110010 / 0044293844	MAX 10 Bar	Man - Mercedes

12.01.004

RELAY VALVES

Oem Ref. No:
9730011200

Desc:
MAX 10 Bar

Vehicle:
Man - Mercedes



12.01.010

RELAY VALVES

Oem Ref. No:
9730112050
0054291044
5010207451
1302103

Desc:
MAX 10 Bar

Vehicle:
DAF
RENAULT
IVECO
TEMESA



12.01.012

RELAY VALVES

Oem Ref. No:
4730170000

Desc:

Vehicle:



12.01.015

RELAY VALVES

Oem Ref. No:
9730010120

Desc:
MAX 8 Bar

Vehicle:
Renault - Man - Iveco - Bmc
NEOPLAN - DAF - VOLVO



12.01.017

RELAY VALVES

Oem Ref. No:
9730012200

Desc:
MAX 10 Bar

Vehicle:
Mercedes - Bmc - Setra



12.01.018

RELAY VALVES

Oem Ref. No:
9730010210
81251506011

Desc:
MAX 10 Bar

Vehicle:
Daf - Neoplan - Mercedes



12.01.019

RELAY VALVES

Oem Ref. No:
9730110500

Desc:
MAX 10 Bar

Vehicle:
DAF
SCANIA



12.01.021

RELAY VALVES

Oem Ref. No:
9730112000
0044297644
81521166071

Desc:
MAX 10 Bar

Vehicle:
MAN (TGA)
MERCEDES (0405)
DAF
IVECO
RENAULT
ERF
NEOPLAN



12.01.023

RELAY VALVES

Oem Ref. No:
9730112010

Desc:

Vehicle:
DAF



12.01.024

RELAY VALVES

Oem Ref. No:
9730112020

Desc:

Vehicle:
DAF



12.03.007

ROTARY SLIDE VALVE

Oem Ref. No:
SV3111
0003290825
0003290425
6773736

Desc:

Vehicle:
MERCEDES
VOLVO



12.03.012

ROTARY SLIDE VALVE

Oem Ref. No:
SV3115
05000787082

Desc:

Vehicle:
RENAULT



12.02.001

CIRCUIT PROTECTION VALVE

Oem Ref. No:

9730060030
0044296344
81521166075

Desc:

10 bar
22x1,5

Vehicle:

MERCEDES ATEGO
DAF CF85
MAN TGA
NEOPLAN



12.02.002

CIRCUIT PROTECTION VALVE

Oem Ref. No:

9730060000

Desc:

16x1,5

Vehicle:

IVECO EUROCARGO



12.02.003

CIRCUIT PROTECTION VALVE

Oem Ref. No:

9730060010
5021170458

Desc:

22x1,5

Vehicle:

MERCEDES
RENAULT



03.07.001

WATER RELIEF VALVE

Oem Ref. No:

4343000000

Desc:

Vehicle:



03.09.001

WATER SEPERATOR

Oem Ref. No:

AC951A
9323990000

Desc:

CONDENSER

Vehicle:



03.08.001

DRAIN VALVE

Oem Ref. No:

EE4107
K000745

Desc:

Vehicle:

LIAZ
5256
5292
6212



04.01.001 FOOT BRAKE VALVE

Oem Ref. No: 4613150080
85500014354
0014318305

Oil:

Vehicle: MERCEDES 2521-3031



RK.04.001

REPAIR KITS

Oem Ref. No: 4613150052
0014300460
42493947 / 5000821899
5021170164 / 697422
81521306104



04.02.001 FOOT BRAKE VALVE

Oem Ref. No: 4613190080
0024310605

Oil:

Vehicle: MERCEDES



RK.04.002

REPAIR KITS

Oem Ref. No: 4613190072



04.02.005 ROTARY SLIDE VALVE

Oem Ref. No: 4630320200
0003275125
81436166004
42089956
5001871034
0243112800

Desc:

Vehicle: MAN
MERCEDES
DAF
RENAULT
IVECO
BPW



04.02.010 ROTARY SLIDE VALVE

Oem Ref. No: HB 1176

Desc:

Vehicle:



20.01.001

GEARBOX VALVE

Oem Ref. No:
SV3368

Oil:

Vehicle:



RK.20.007

REPAIR KITS

Oem Ref. No:



20.01.003

GEARBOX VALVE

Oem Ref. No:
3092123
1669324
1869324
1069841
1672042

Oil:

Vehicle:



RK.20.001

REPAIR KITS

Oem Ref. No:



20.01.004

GEARBOX VALVE

Oem Ref. No:
1669297

Desc:

Vehicle:



20.01.005

GEARBOX VALVE

Oem Ref. No:
SV3371
0012608457
0002605457
0012603557
0012604757

Desc:

Vehicle:
MERCEDES
30-31



20.01.007

GEARBOX VALVE

Oem Ref. No:
1319557

Desc:

Vehicle:
SCANIA



20.01.008

GEARBOX VALVE

Oem Ref. No:
SV3302

Oil:

Vehicle:



RK.20.003

REPAIR KITS

Oem Ref. No:



20.01.009

GEARBOX VALVE

Oem Ref. No:
1334037
1423566
1488083

Desc:

Vehicle:
SCANIA

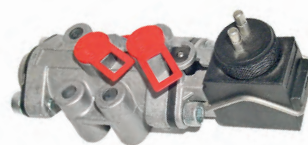

20.01.010

GEARBOX VALVE

Oem Ref. No:
1303948

Desc:

Vehicle:
DAF



20.01.014

GEARBOX VALVE

Oem Ref. No:
1457276
1379776
1457276A
1457276R

Desc:

Vehicle:
DAF



20.01.011

GEARBOX VALVE

Oem Ref. No:
0022602457
0022602357
0022604157
0022606157

Oil:

Vehicle:
MERCEDES
ACTROS



RK.20.013

REPAIR KITS

Oem Ref. No:

Vehicle:
MERCEDES
ACTROS



20.01.012

GEARBOX VALVE

Oem Ref. No:
6038202035
6038202043
81521316017
3238205 / 121-021
42538044

Desc:

Vehicle:
MAN F2000 / 19.403
KAMAZ / DAF / IVECO / REN
PRO-109'LUK ŞANZUMAN



20.01.013

GEARBOX VALVE

Oem Ref. No:
81521706156
81521706096

Desc:

Vehicle:
MAN



20.01.016

GEARBOX VALVE

Oem Ref. No:
1068952

Oil:

Vehicle:



RK.20.010

REPAIR KITS

Oem Ref. No:



20.01.018

GEARBOX VALVE

Oem Ref. No:
1068951

Oil:

Vehicle:



RK.20.008

REPAIR KITS

Oem Ref. No:



20.01.021

GEARBOX VALVE

Oem Ref. No:
0022603057
0022602957
0022606257

Desc:

Vehicle:
MERCEDES
ACTROS



20.05.001

HOUSING SHIFTING CYLINDER

Oem Ref. No:
0002670519
ZF NO: 1296312042

Desc:

Vehicle:
MERCEDES



20.05.002

HOUSING SHIFTING CYLINDER

Oem Ref. No:
1652857
1656239

Desc:

Vehicle:
VOLVO



20.05.004

HOUSING SHIFTING CYLINDER

Oem Ref. No:
0002670419
0002670819
0002672119

Desc:

Vehicle:
MERCEDES

ZF NO: 1295334075



21.01.001

QUICK RELEASE VALVE

Oem Ref. No:
9735000000
4735010010

Oil:
22X1.5

Vehicle:



52.03.001

OIL FYLTER

Oem Ref. No:
4200900352

Oil:

Vehicle:
MERCEDES
2521
2524



69.01.002

STEERING WHEEL HYRUEALIC CUP

Oem Ref. No:
0481062413
0004665502

Däsc:

Vehicle:
MERCEDES



69.01.003

STEERING WHEEL HYRUEALIC CUP

Oem Ref. No:
8847033240

Oil:

Vehicle:
MERCEDES



07.02.001

FUEL FILTER

Oem Ref. No:
0000906050
0000907350

Oil:

Vehicle:
MERCEDES



78.01.003

ALCOHOL VALVE

Oem Ref. No:
0484451013

Oil:

Vehicle:



83.01.001

PRESSURE ADJUSTMENT VALVE

Oem Ref. No:
0481009022

Oil:

Vehicle:
MERCEDES
M16X1,5



83.01.002

PRESSURE ADJUSTMENT VALVE

Oem Ref. No:
0481009050

Oil:

Vehicle:
MAN
M22X1,5



83.01.007

PRESSURE ADJUSTMENT VALVE

Oem Ref. No:
4750150310

Oil:
7.5 BAR

Vehicle:
IVECO



83.01.010

PRESSURE ADJUSTMENT VALVE

Oem Ref. No:
4750103000
4750102000
81521016269

Oil:
8.5 BAR
8 BAR

Vehicle:
MAN TGA / 33.360
DAF



83.01.011

PRESSURE ADJUSTMENT VALVE

Oem Ref. No:
4750154010

Oil:
4.4 BAR

Vehicle:
NATO



83.02.015

PRESSURE ADJUSTMENT VALVE

Oem Ref. No:

Oil:

Vehicle:



51.01.006

PRESSURE VALVE

Oem Ref. No:
DR5118

Oil:

Vehicle:
15 Bar



51.01.007

PRESSURE VALVE

Oem Ref. No:
DR5125
51541220007
51541220011

Oil:

Vehicle:
17 Bar



04.02.006

STOP COCK

Oem Ref. No:
4520021070

Oil:

Vehicle:



22.01.001

DIRECTIONAL CONTROL VALVE

Oem Ref. No:
4630360000
0019975036
81521856015

Oil:

Vehicle:



91.01.001

STEERLING

Oem Ref. No:
523070

Oil:

Vehicle:



77.01.001

OIL RADIATOR HEAD

Oem Ref. No:
4031841108
4031302438

Oil:

Vehicle:





MERCEDES	02 / 106
MAN	110 / 218
VOLVO	222 / 319
SCANIA	322 / 356
DAF	360 / 410
RENAULT	414 / 467
IVECO	470 / 521
FORD&BMC CUMMINS	524 / 556
DEUTZ	560 / 573
MAGIRUS	576 / 585
IKARUS	588 / 591
OTHER BRANDS	594 / 620
GEARS	624 / 631
CLUTCH SERVO	634 / 695
VALVES	698 / 755

OTHER PARTS	758 / 765
------------------------	------------------

13.01.001

BALL JONT

Oem Ref. No:
0002684889
0002685289

Oil:

Vehicle:
RIGHT



13.01.002

BALL JONT

Oem Ref. No:
0002684689
0002686289

Oil:
7.5 BAR

Vehicle:
LEFT



25.01.001

THE ROTTLE PEDAL KIT

Oem Ref. No:
6243000304

Oil:

Vehicle:



38.02.001

GLASS SWITCH ARM

Oem Ref. No:

Oil:

Vehicle:
MERCEDES



38.02.002

GLASS SWITCH ARM

Oem Ref. No:

Oil:

Vehicle:
MERCEDES



38.02.003

GLASS SWITCH ARM

Oem Ref. No:

Oil:

Vehicle:
SCANIA



38.02.004

GLASS SWITCH ARM

Oem Ref. No:
673760002

Oil:

Vehicle:
MERCEDES NEW MODELL



42.02.001

DOOR ARM

Oem Ref. No:
3817660043

Oil:

Vehicle:
MERCEDES



42.02.002

SHUTTER ARM LEFT

Oem Ref. No:
9417500302

Oil:

Vehicle:
MERCEDES



42.02.003

Door Arm Latch

Oem Ref. No:
6417230088

Oil:

Vehicle:
MERCEDES



42.02.004

DOOR ARM LATCH LEFT

Oem Ref. No:
9418900572

Oil:

Vehicle:
MERCEDES



42.02.005

DOOR ARM LATCH RIGHT

Oem Ref. No:
9418900472

Oil:

Vehicle:
MERCEDES



18.01.001

FULLER GEAR SHIFT HANDLE

Oem Ref. No:

Oil:

Vehicle:

ONE CIRCUIT



18.01.002

FULLER GEAR SHIFT HANDLE

Oem Ref. No:

Oil:

Vehicle:

4630531070

TWO CIRCUITS



18.02.001

GEAR MACE

Oem Ref. No:

Oil:

Vehicle:

81970106011

MAN
ONE CIRCUIT



18.02.002

GEAR MACE

Oem Ref. No:

Oil:

Vehicle:

81970106009

MAN
TWO CIRCUITS



18.02.003

GEAR MACE

Oem Ref. No:

Oil:

Vehicle:

81326200043

MAN



18.02.004

GEAR MACE

Oem Ref. No:

Oil:

Vehicle:

81326200045

MAN



74.01.002

OIL FILTER COVER

Oem Ref. No:

5411840208
4571840008

Oil:

Vehicle:

MERCEDES
ACTROS / OM501-502
AXOR 457-1841-184840N
Ø 145 mm

74.01.003

FUEL FILTER COVER

Oem Ref. No:

0000924708
0000925208

Oil:

Vehicle:

MERCEDES
ACTROS
AXOR 457-906-206625N
Ø 119 mm

74.01.004

OIL FILTER COVER

Oem Ref. No:

51055056002

Oil:

Vehicle:

MAN - 2866 - 2876
TGA / 410 - 423 - 460
463 - 464

74.01.005

FUEL FILTER COVER

Oem Ref. No:

51125046003

Oil:

Vehicle:

MAN
TGA / 410 - 46025N
Ø 107 mm

62.01.001

EXPANSION COVER

Oem Ref. No:

0004760068
81061110018

Oil:

Vehicle:

MAN



62.01.002

EXPANSION COVER

Oem Ref. No:

0004760068

Oil:

Vehicle:

MERCEDES



08.05.001

MIRROR BRACKET BOTTOM

Oem Ref. No:
6418100012

Oil:

Vehicle:



08.06.002

MIRROR BRACKET BOTTOM

Oem Ref. No:
0008101025

Oil:

Vehicle:
MERCEDES
ACTROS



08.05.002

MIRROR BRACKET

Oem Ref. No:
6418110326

Oil:

Vehicle:
MERCEDES



08.02.001

MIRROR BRACKET

Oem Ref. No:
3818111236

Oil:

Vehicle:
MERCEDES
2521



53.01.014

INTERCOOLER AIR HOSE INNERDIA

Oem Ref. No:
81326200043

Oil:
Ø90-135MM

Vehicle:
SCANIA 113 93

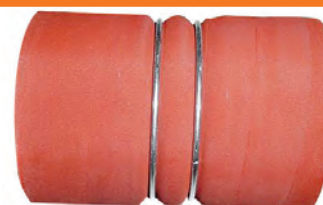

53.01.021

INTERCOOLER AIR HOSE INNERDIA

Oem Ref. No:
81963200165

Oil:
Ø90-Ø75
155MM

Vehicle:
MAN 422



53.01.001

INTERCOOLER AIR HOSE INNERDIA

Oem Ref. No:
3715018082

Oil:

Vehicle:
MERCEDES
2521



53.01.002

INTERCOOLER AIR HOSE INNERDIA

Oem Ref. No:
81963010587

Oil:

Vehicle:
MAN 422



53.01.003

INTERCOOLER AIR HOSE INNERDIA

Oem Ref. No:
0020946682
0020945582

Oil:

Vehicle:
MERCEDES
ACTROS



53.01.004

INTERCOOLER AIR HOSE INNERDIA

Oem Ref. No:
81963010668

Oil:

Vehicle:
MAN 463



53.01.005

INTERCOOLER AIR HOSE INNERDIA

Oem Ref. No:
0020945282

Oil:

Vehicle:
MERCEDES 30-31



53.01.006

INTERCOOLER AIR HOSE INNERDIA

Oem Ref. No:
0020946382B

Oil:

Vehicle:
MERCEDES O403



53.01.007

INTERCOOLER AIR HOSE INNERDIA

Oem Ref. No:
4865230EZ
4.GP

Oil:

Vehicle:
IVECO



15.01.001

FLEXIBLE HOSE

Oem Ref. No:
6204900365

Oil:

Vehicle:
Ø80



15.01.002

FLEXIBLE HOSE

Oem Ref. No:
6204900465

Oil:

Vehicle:
Ø95



15.01.003

FLEXIBLE HOSE

Oem Ref. No:
6214900065

Oil:

Vehicle:
Ø105



63.01.001

FLEXIBLE HOSE

Oem Ref. No:

Oil:

Vehicle:



28.01.001

GAS THROTTLE

Oem Ref. No:
3813000728
6203000628
6203001128

Oil:

Vehicle:



107.01.001

BRAKE DISK

Oem Ref. No:

9424210912
9424211012
9424211112
9424211212
9424212112
9424230012

Oil:

Vehicle:

MERCEDES AXOR - ACTROS
OLD TYPE



107.01.005

BRAKE DISK

Oem Ref. No:

81508030041
81508030021

Oil:

Vehicle:

MAN TGA
F2000 FORTUNA



107.01.006

BRAKE DISK

Oem Ref. No:

81508030040

Oil:

Vehicle:

MAN TGA
F2000 FORTUNA



107.01.009

BRAKE DISK

Oem Ref. No:

9064210012

Oil:

Vehicle:

MERCEDES
AXOR



107.01.011

BRAKE DISK

Oem Ref. No:

0308835050
0308835057

Oil:

Vehicle:

BPW KÖGEL
KRONE



107.01.012

BRAKE DISK

Oem Ref. No:

0308835050
0308835057

Oil:

Vehicle:

BPW KÖGEL
KRONE



Version
1.2.6

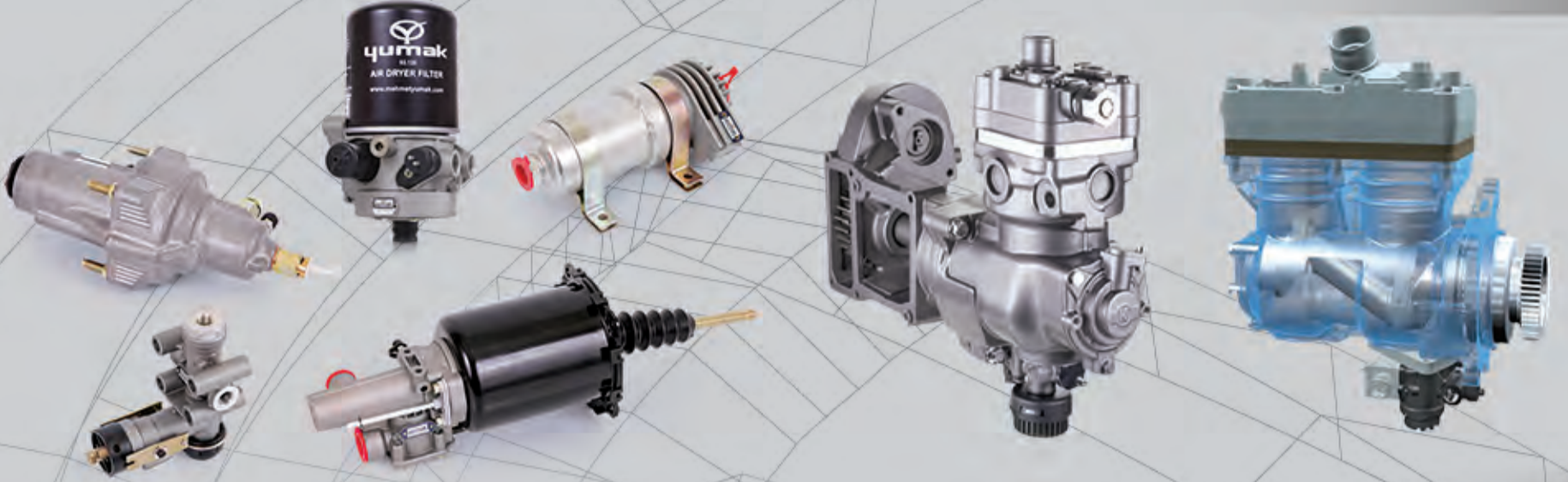

Adres: Konya Organize Sanayi Bölgesi Büyük Kayacık Mahallesi T.Ziyaeddin
Caddesi No:14 Selçuklu/Konya/TÜRKİYE

Tel: +90 332 346 36 60 // +90 332 444 1 965
Faks: +90 332 346 36 65

info@mehmetyumak.com // satis@mehmetyumak.com
www.mehmetyumak.com

Yumak Otomotiv'e sosyal medyadan ulaşmak için;

facebook /yumakautomotive

twitter /yumakautomotive